

COMBI QUICK START GUIDE

FT WALL MOUNTED AND FLOORSTANDING



DHW Set Point	2
High Temp DHW Set Point	3
Outdoor Reset	4-7
Installer Parameters	8-9
Measuring & Adjusting CO ₂	10-12

⚠ WARNING

This Quick Start Guide is supplemental to the Installation and Operating Manual for the FT Combi. The installation of the combination (Wall or Floor) must be per the Installation and Operating Manual for that unit (1487 Wall, or 1505 Floor) first and per requirements of the manual and within the guidelines of all local codes **BEFORE** starting with this Quick Start Guide.

If the information in the Install and Operating Manual (1487 Wall, or 1505 Floor) is not followed exactly, a fire or explosion may result causing property damage, personal injury or loss of life.

⚠ AVERTISSEMENT

Ce guide de démarrage rapide complète le manuel d'installation et d'utilisation du FT Combi. L'installation de la combinaison (mur ou sol) doit d'abord être conforme au manuel d'installation et d'utilisation de cette unité (mur 1487 ou sol 1505) et conformément aux exigences du manuel et aux directives de tous les codes locaux **AVANT** de commencer avec ce démarrage rapide. Guider.

Si les informations contenues dans le manuel d'installation et d'utilisation (mur 1487 ou sol 1505) ne sont pas suivies à la lettre, un incendie ou une explosion peut en résulter, causant des dommages matériels, des blessures corporelles ou la mort.

Display

Mode Button DHW Button

Call for:

- CH
- DHW
- Internal Storage

Display Power/Reset Scroll/Select Dial

- CH Button
- F/C
- Calculated setpoint

Programming DHW Set Point

1. Press DHW button.



The DHW icon will appear on the screen.

2. Turn the Scroll/Select dial to adjust to desired set point.



3. Press the Scroll/Select dial to save your selection.



Programming High Temp DHW Set Point

Note: The DHW high set point can be adjusted to a maximum of 140° F.
An Anti-Scald device is required for FT Floor units and FT Wall units when DHW is set above 120° F.

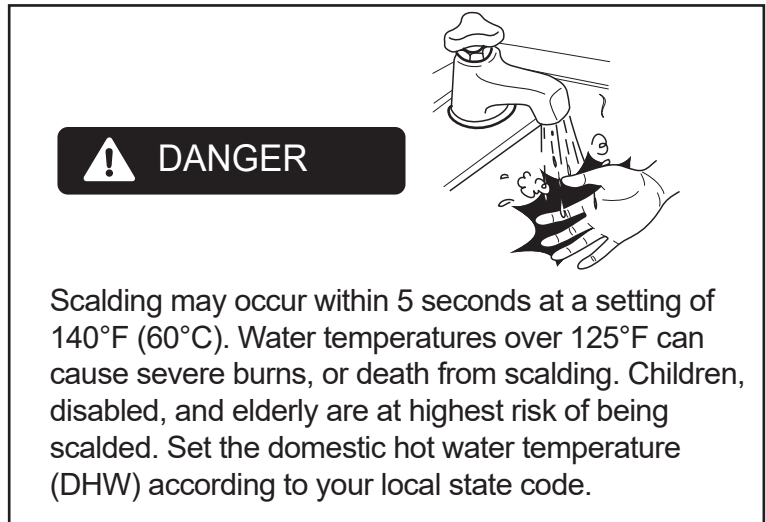

1. Press DHW button.

The DHW icon will appear on the screen.



2. Then press and Hold DHW button until "H" appears on the screen.

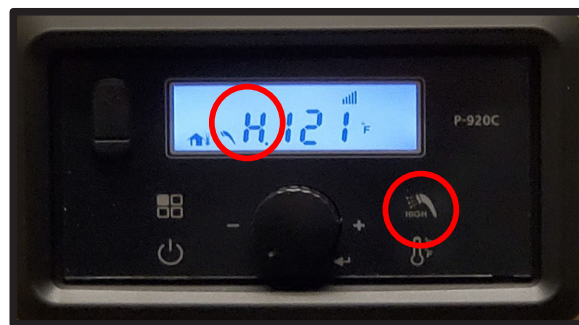

3. Turn the Scroll/Select dial to adjust desired set point.
4. Press the Select/Scroll dial to save your selection.



Display

Mode Button DHW Button

Call for:

- CH
- DHW
- Internal Storage

Display Power/Reset Scroll/Select Dial

- CH Button
- F/C
- Calculated setpoint

Outdoor Reset - Connections

Wall Mounted Combi Unit

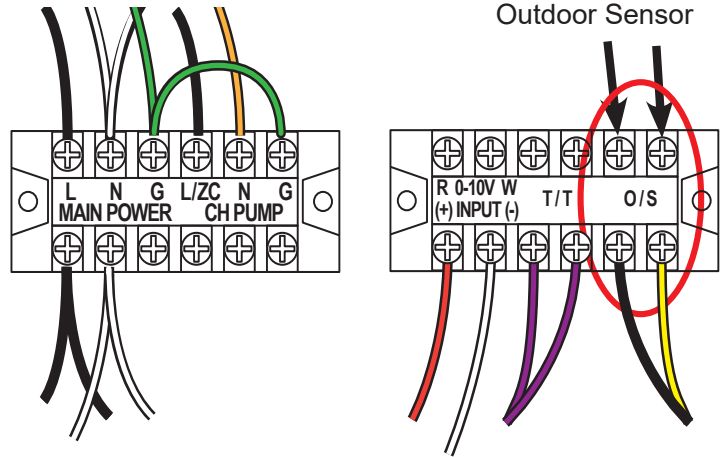

Floorstanding Combi Unit

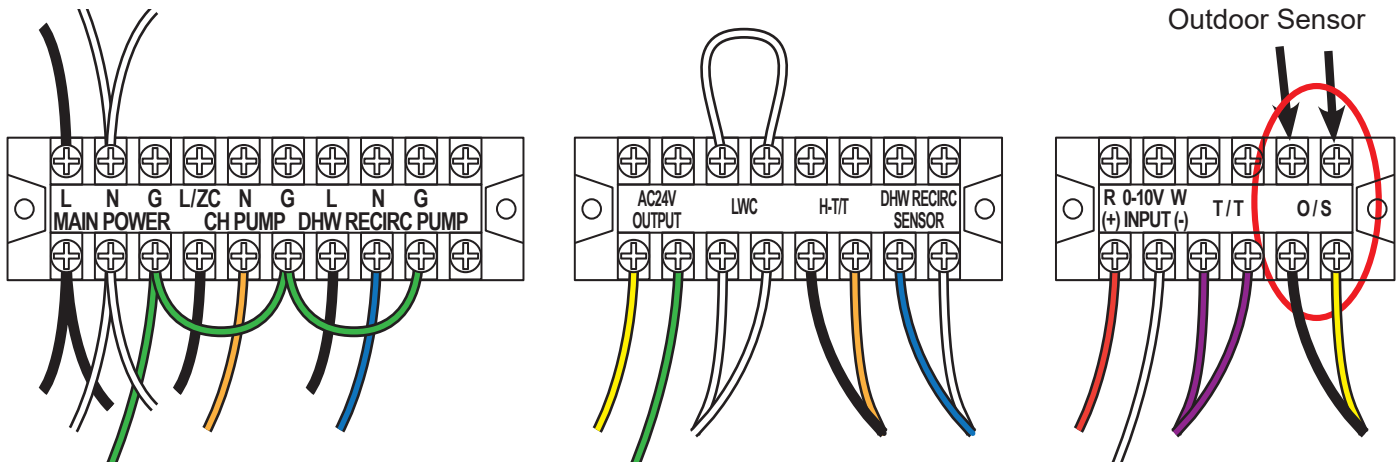

Understanding Outdoor Reset Adjustment

Outdoor Reset varies the control set point based on the outdoor temperature. The reset function works as shown in Figure 'CH Outdoor Reset'. When the outdoor air temperature reaches 6:OH "high outdoor temperature set point", the control point setting is adjusted to 17:cL "low boiler temperature set point". When the outdoor air temperature reaches 7:OL "low outdoor temperature set point" the control set point is adjusted to 16:cH "high boiler temperature".

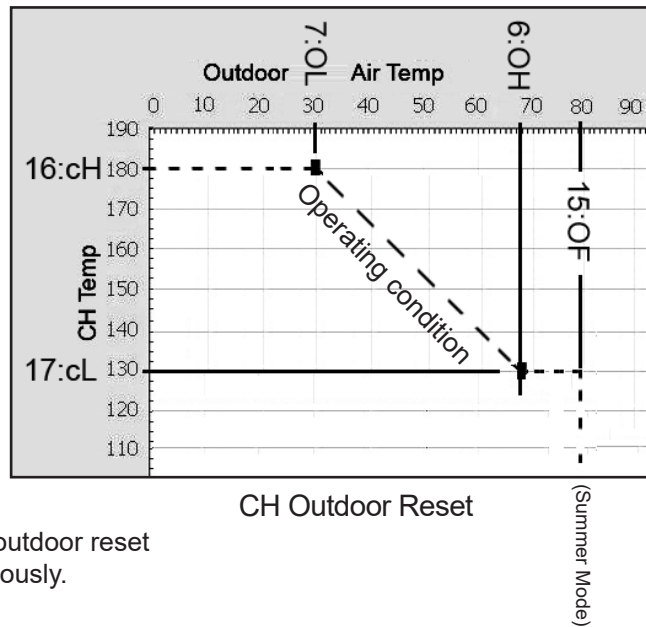

NOTE: 0 - 10VDC terminals may not be used for both outdoor reset and 0 - 10VDC temperature set point simultaneously.

Programming Outdoor Reset

Outdoor Reset is defaulted for high temp boiler applications. To adjust outdoor reset follow these steps.

1. Power off the display.
2. Press and HOLD the Mode button until **1:EH** appears.
3. Turn the Scroll/Select dial to **6:OH** (Outdoor high Temperature).
4. Press and release the Scroll/Select dial to enter this program step.
5. Turn the Scroll/Select dial to desired High Outdoor Temperature.
6. Press and release the Scroll/Select dial to save the setting.



Programming Outdoor Reset

7. Turn the Scroll/Select dial to **7:OL**
(Low Outdoor Temperature).



8. Press and release the Scroll/Select dial to enter this program step.

9. Turn the Scroll/Select dial to desired Low Outdoor Temperature.



10. Press and release the Scroll/Select dial to save the setting.

11. Turn the Scroll/Select dial to **15:OF**
(Warm Weather Shut Down).



12. Press and release the Scroll/Select dial to enter this program step.

13. Turn the Scroll/Select dial to the desired WWSD Temperature.



14. Press and release the Scroll/Select dial to save the setting.

Programming Outdoor Reset

15. Turn the Scroll/Select dial to **16:cH**
(Maximum CH temperature).



16. Press and release the
Scroll/Select dial to enter this
program step.

17. Turn the Scroll/Select dial to
desired Maximum CH Temperature.



18. Press and release the Scroll/Select
dial to save the setting.

19. Turn the Scroll/Select dial to **17:cL**
(Minimum CH temperature).



20. Press and release the Scroll/Select
dial to enter this program step.

21. Turn the Scroll/Select dial to desired
Minimum CH Temperature.



22. Press and release the Scroll/Select
dial to save the setting.

23. Press and release the Mode button
to power down the display.



24. Press and release the Power button
to turn the display power back on.

Your Outdoor Reset Curve has now
been set to your desired parameters.

NOTE: When not using an outdoor sensor, refer to Section 5.6 in the Installation & Operating Manual to adjust the CH setpoint when necessary.

Installer Parameters

Index	Default	Parameter	Description
1: EH		Error History	History fault code (E0~E9)
2: cE	OFF	Clear Error History	Clearing of error History buffer
3: In	OFF	System initialize	System initialize to default
4: Fu	GA	Flow unit	gallon / liter
5: St	On	Heat storage function	Heat storage function On/Off
6: OH	68°F (20°C)	Maximum Outdoor Temperature	Range: (Minimum Outdoor Temperature + 9°F) to 110°F
7: OL	30°F (-1°C)	Minimum Outdoor Temperature	Range: -4°F to (Maximum Outdoor Temperature -9°F)
8: FH	0	Max fan	Adjusts Maximum Fan Speed Range: -30 - +30 Default 00 Note: Factory set - do not adjust
9: FL	0	Min fan	Adjusts Minimum Fan Speed Range: -30 -+30 Note: Factory set - do not adjust
10: dr	NO	Delete running time	Delete running time
11: dl	NO	Delete igniting times	Delete igniting times
12: bt	0	Outdoor reset Boost Delay Time	When using the outdoor reset sensor, if a call for heat is longer than Boost delay time, the boiler will Boost to the maximum supply water temperature - see parameter 16CH. (0~120 min)
13: Ft	1 min	Delay time for heating burner operation	Burner does not operate during the delay time when the burner is turned off due to the temperature during heating operation. (0~20 min)
14: bo	15°F (10°C)	Burner ON differential	Heating temperature setting during heating operation – Operate in burner ON temperature setting Range: 9 - 27°F (5 - 15°C)
15: OF	110°F (38°C)	Warm Weather Shutdown	This warm weather temperature setting will shut down CH Mode. Range: 50 - 110°F (10 - 43°C).
16:cH	180°F (82°C)	Setting for Heating Maximum Temperature	Range: 9°F less than Minimum Temperature to 180°F 5°C less than Minimum Temperature to 82°C
17:cL	130°F (54°C)	Setting for Heating Minimum Temperature	Range: 86°F to 9 degrees °F less than Maximum Temperature
18:dH	140°F (60°C)	Setting for Hot Water Maximum Temperature	Range: 120°F - 140°F (49°C to 60°C)
19:cb	100%	Heating Combustion Rate	Range: 50%~100%
20:db	100%	Hot Water Combustion Rate	Range: 50%~100%
21:PP	40 min	Boiler pump post burner limit run time	(Boiler Pump) 1 min - 60 min. As long as TT is closed, boiler and system pump both run, even when boiler hits high limit. (TT is closed).
22:Po	5 min	Pump on Time	(Boiler Pump Repeat ON Time) Range: 1 min ~60 min (While TT is closed)
23:PF	0 min	Pump off Time	(Boiler Pump Repeat Off Time) Range: 0min ~60 min (While TT is closed)
24:SF	150°F (66°C)	Storage off temperature	Range: 140°F - 180°F (60°C to 82°C)
24:SF	105°F (41°C)	DHW Recirculation off temp (when DHW/Surface sensor is connected)	Range: 95°F - 140°F (35°C to 60°C) The range is automatically changed when DHW/Surface sensor is connected.
25:So	18°F (10°C)	Storage on Δtemp	Range: 9°F - 36°F (5°C to 20°C)
25:So	9°F (5°C)	DHW Recirculation on temp (when DHW sensor or aquastat is connected)	Range: 9°F - 27°F (5°C - 15°C) The range is automatically changed.
26:dt	0 min	Smart DHW Priority Delay time	Range: 0 – 2 minutes. If Smart DHW Priority is ON (see parameter P36), a call for domestic hot water will be prioritized by the boiler for delay time value. The boiler will turn heating back on as long as boiler can satisfy both domestic and heating demands otherwise, heating will remain off until domestic demand has ended.
27:PE	1 min	Internal Boiler Pump and system pump Post-Purge Time, T/T Satisfied	Allows the user to set the boiler pump and system pump post purge time once the appliance CH set point and thermostat are satisfied. Range: 1-5 minutes
28: HA	0-2	High Elevation Mode	High Elevation Mode: 0 - 2, 2 - 5, 5 - 8, 8 - 10 Default: 0 - 2 0 - 2: 0 - 2,000 ft 2 - 5: 2,000 - 5,000 ft 5 - 8: 5,000 - 8,000 ft 8 - 10: 8,000 - 10,000 ft

Installer Parameters (cont)

Index		Default	Parameter	Description
29: AP	AP:cP	5	CH System Pump and DHW Indirect Pump Test Mode	This function sets the time to run Boiler pump to purge air from the system. Range: 1 – 30 minutes
	cP:Off or cP:On	OFF	Boiler Pumps Test Mode	Turn this function on to activate Boiler pump. Only works in installation mode. Turns off when in normal mode.
30: dP		4 hrs	DHW Timeout Feature	Range: 0 - 12 hours, '0' OFF
31: SA	AqUA	dHr	Select AqUA or dHr	Select Storage Type, Aquastats or DHW-recirc Sensor (Affects P24: SF, P25: So) - Aqua: DHW Recirculation Operation with aquastat (not supplied) - dHr: DHW Recirculation Operation with DHW-R / surface sensor (optional equipment) - dHr Sensor not connection: Storage Operation
	dHr			
32: rC		15 min	DHW in stand-by, DHW recirc pump not running for recirc for 15 min. (Applies when not using DHW-R sensor or aquastat; pairs with P33)	Range: 1 – 60 (min) To run continuously between rC and rt If flow is detected, rC timer resets to zero.
33: rt		10 min	DHW recirc pump run time to reach DHW recirc temp.	
34: HF		80%	Hybrid Off Firing Rate (DHW mode change: CH-Off, DHW ON)	Activated during "Smart" DHW function, Boiler firing rate has reached set maximum heating rate, deactivate the external CH pump for DHW priority, Range 50 - 90%
35: Hn		50%	Hybrid On Firing Rate (CH mode change: CH + DHW)	During activate "Smart" DHW function, Boiler firing rate has reached set minimum firing rate, activate external CH pump, Range 30 - 50%
36 : Ho		ON	"Smart" DHW mode: ON/OFF	Activate "Smart" DHW operating function: ON/OFF When set to ON, it operates in hybrid mode. When set to OFF, it operates in normal mode. (DHW priority)

Parameters 31 to 36 are for the floor model combi units only.

Measuring and Adjusting CO2

1. Turn on Gas and Water supply to the FT models
2. Remove the plug located in the vent pipe adaptor and set up your gas analyzer.

CO2 adjustments are made ONLY when the boiler is in "Min Fire"

3. Set DIP Switch #7 to the ON position to run boiler in "Min Fire".

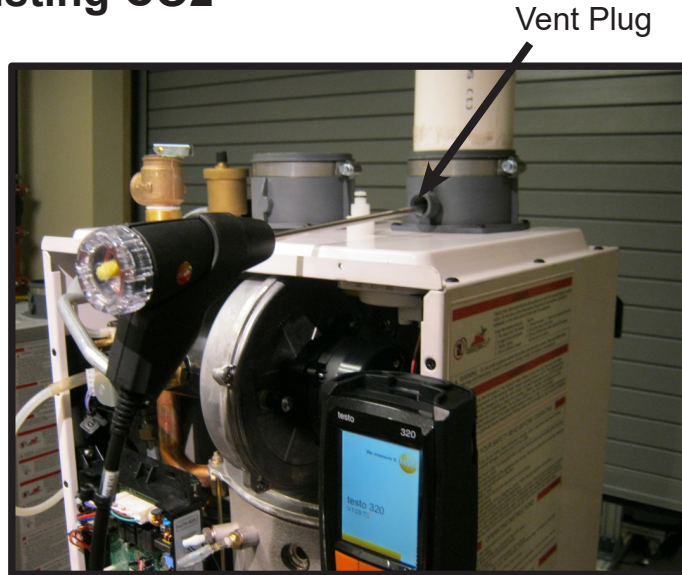

NOTES: Only DIP switches 6 and 7 are moved when adjusting CO2. DO NOT adjust DIP switches 1 thru 3 from factory settings. Adjust DIP switches 4 & 5 based on application.

	ON	OFF
MIN Fire	Normal Operation	Normal Operation
MAX Fire	Normal Operation	Normal Operation
NG Natural	LP Propane	LP Propane
3" Vent Size	2" Vent Size	2" Vent Size

MBH 140

MBH 199

This example is a wall **Model 140** with 3" Venting and using Natural Gas in Normal Operation

This example is a wall **Model 199** with 3" Venting and using Natural Gas in Normal Operation

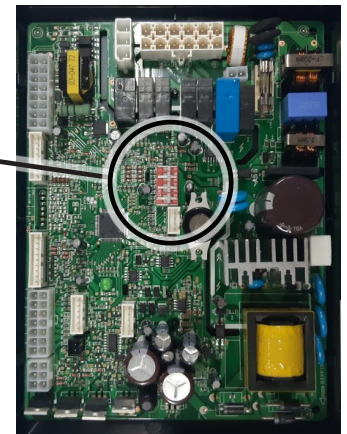

Wall Models
Floor Models

NOTE: Control boards for wall-hung and Floor models are NOT the same.

MBH 199

NO

This example is a floor **Model 199** with 3" Venting and using Natural Gas in Normal Operation

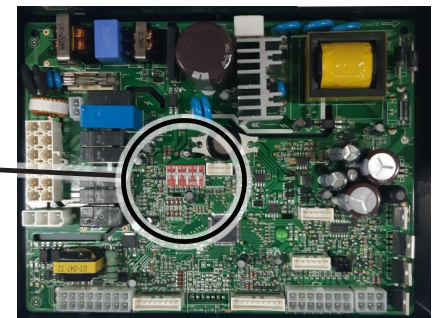

Combustion Setup

CO2 Value	Natural Gas (NG)		Propane Gas (LP)	
	2" VENT	3" VENT	2" VENT	3" VENT
MAX FIRE	8.5 - 10.5%		9.5 - 11%	
MIN FIRE	8 - 10%		9 - 10.5 %	

ALL COMBI SIZES (and all altitudes)

Gas Inlet Port

CO2 Adjustment

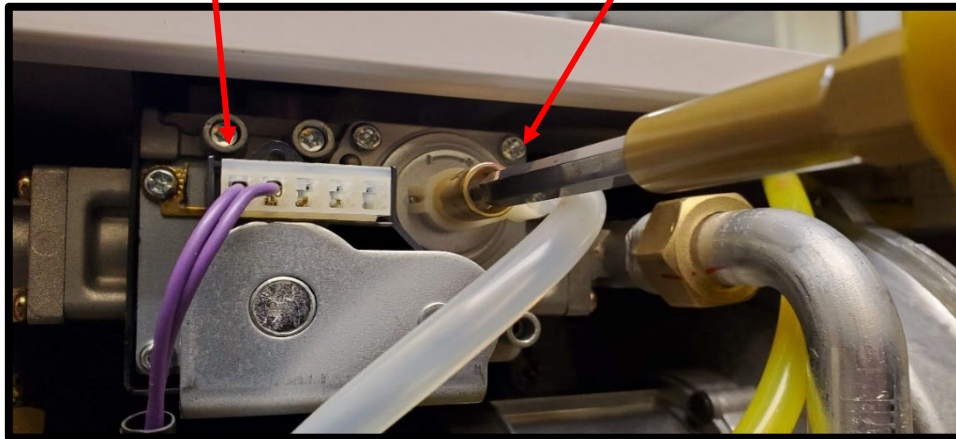

NOTE: FTCW199 Gas Valve Shown. Depending on your model number, gas valve location may be different.

5. Adjusting CO2. Remove the Cap Screw. Use a T15 Torx wrench to adjust gas valve.
6. Once you have measured and adjusted CO2 in "Min Fire", then-
7. Set DIP Switch #7 to OFF and switch #6 to ON. This will fire the boiler at "Max Fire"

DO NOT MAKE ADJUSTMENTS IN MAX FIRE

8. If CO2 "Max Fire" is too low you will need to go back to "Min Fire" and adjust to bring CO2 up.
9. If "Max Fire" is too high you will need to go back to "Min Fire" and adjust to bring CO2 down.

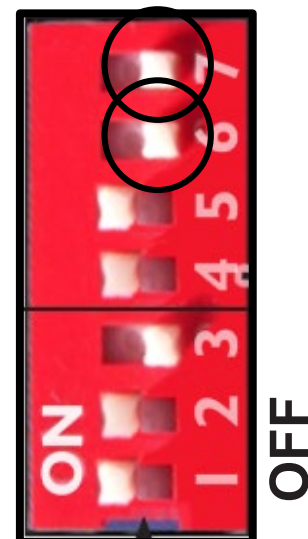

12. Once the CO₂ has stabilized and is within specification, set DIP Switches 6 and 7 to the “OFF” position (Normal Operation).
13. Remove all test equipment, re-install the combustion port test plug.
14. Fasten the boiler cover back onto the boiler.



Customer Service and Product Support: 800.900.9276 • Fax 800.559.1583
20 Industrial Way, Rochester, NH, USA 03867