

# tekmar® - Data Brochure

4 – Way Mixing Valves 016 – 026

Available at: 888-470-2757  
PEXHEAT.COM

D 016

10/00

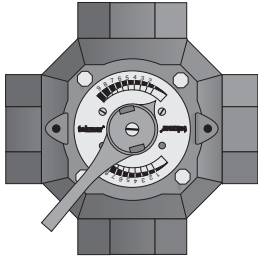

The tekmar 4 – Way Mixing Valves 016 - 026 mix supply water from a source with water returning from a system. The valve can be automatically operated by utilizing a tekmar Actuating Motor and a floating action control signal. This precision valve is manufactured to the highest quality standards for a long trouble free service. It is designed for use in closed loop hydronic systems with properly treated water. The valve provides a maximum of 1% leak through rate to allow for water expansion during temperature changes. The valve ports are characterized to provide a proportional water temperature change relative to the scale on the face plate of the valve.

## Sequence of Operation

When the valve flap is in the fully closed position, 100% of the boiler supply water is returned to the boiler and 100% of the heating system return water is supplied to the system. When the valve flap is in the fully open position, 100% of the boiler supply water enters the heating system and 100% of the heating system return water returns to the boiler. Mixing of the water takes place when the valve flap is in an intermediate position.

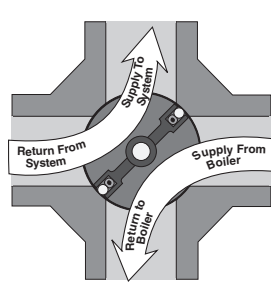

Valve flap in the closed position

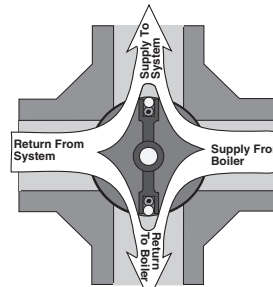

Valve flap in an intermediate (mixing) position

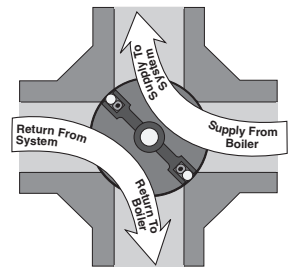

Valve flap in the open position

## Installation of tekmar 4–Way Mixing Valves

### STEP ONE — GETTING READY

Check the contents of this package. If any of the items listed below are missing or damaged, please refer to the Limited Warranty and Product Return Procedure on the back of this brochure and contact your wholesaler or local tekmar representative.

- Types 016 - 019 includes • One Mixing Valve & One Data Brochure D 016
- Types 024 - 026 includes • One Mixing Valve & One Data Brochure D 016

### STEP TWO — MOUNTING

**Note** If types 024-026 are assembled and welded "in place", the flap assembly must be removed from the valve body when welding since excessive heat will damage the internal rubber seals. Also, do not use the valve body to "square" the flanges.

Configuration	Configuration Options	Wiring
<p><b>#1 Valve Closed</b></p>	<p>As Delivered, No changes required.</p> <p><b>Note:</b> The tear drop shaped ports are the outlets to the boiler and to the system.</p>	<p><b>Mixing valve control</b></p> <p><b>Actuating motor</b></p>
<p><b>#2 Valve Closed</b></p>	<p>Turn the valve over until the handle's pointer and marker pegs are pointing down. Remove marker pegs and re-install in upper two holes. Remove the handle, rotate it 180° and re-install it.</p>	<p><b>Mixing valve control</b></p> <p><b>Actuating motor</b></p>

## Valve Maintenance

The body of the tekmar mixing valve is constructed from cast iron which has been found to be the most economical and suitable material for the high stress environment in which the valve operates. As with all ferrous components in a hydronic system, certain precautions are required in order to prevent any appreciable corrosion from occurring. When the mixing valve is used with a tekmar mixing reset control, the control ensures that the valve is fully opened and fully closed every three days. During this exercising period, a stainless steel roller seal scrapes the corrosion products off the inside of the valve in order to prevent the valve flap from seizing.

In some automatic systems, an exercising function is not provided and the mixing valve flap is not rotated through its full range. A build up of corrosion outside the normal range of motion can result in the valve flap jamming when a greater movement is required. This is typically found in systems where the valve is oversized for most of the heating season and is then required to supply additional heat on a very cold day. One indication of a seized valve flap is a broken shear pin on the actuating motor shaft or a broken coupling. Before replacing the shear pin or coupling, carefully disassemble and clean the valve. If corrosion is not evident, ensure the system is free from any foreign material that may have lodged in the valve.

**Note:** Damage to the valve due to foreign objects or excessive corrosion is not covered under warranty.

When the mixing valve is used manually, adequate corrosion control must be provided and the valve flap should be rotated through its full range on a regular basis in order to prevent seizure. If the valve flap does become jammed, do not force it to move as internal components may be damaged. A seized valve must be carefully disassembled and cleaned. To disassemble the valve, remove the 4 bonnet bolts and carefully pull the flap assembly out of the valve body.

### Cleaning the Mixing Valve

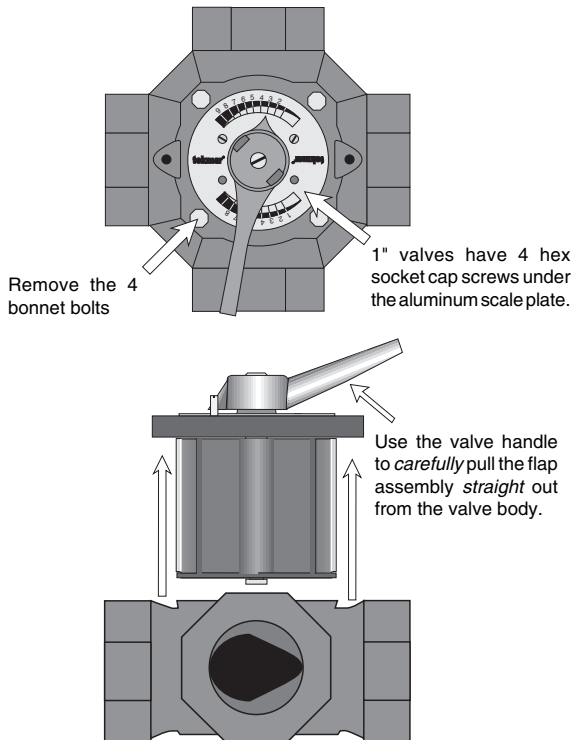

After removing the flap assembly, carefully remove rust and scale from the valve body and flap assembly using steel wool or emery cloth. The valve should be lubricated with a waterproof high temperature grease before it is reassembled.

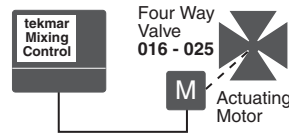

To reduce the possibility of damage to the valve, install a tekmar Mixing Control with an "exercising function".

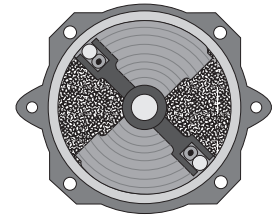

When the valve flap is exercised regularly, the full range of motion of the mixing valve remains free of corrosion.

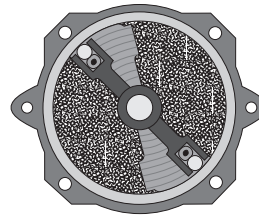

Corrosion build up within a valve due to poor water quality and a limited range of valve flap motion.

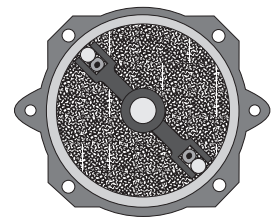

Corrosion buildup within a manual valve due to poor water quality and infrequent valve flap movement.

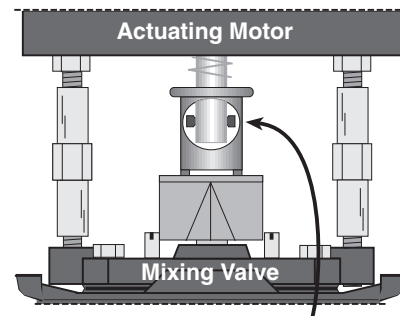

Shear pin provides break point when maximum stress force is reached. A broken shear pin is an indication that the valve has jammed.

### Exploded View All Valve Parts Less Cast Iron Body

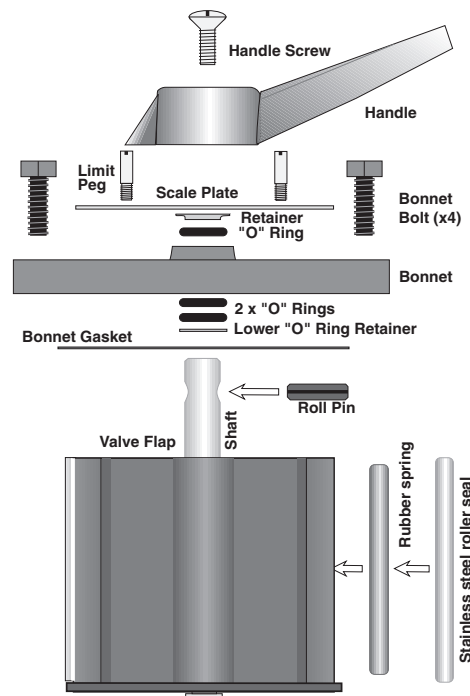

## Corrosion Control

Corrosion occurs when metals are placed in a liquid environment in which the liquid has a high oxygen or mineral content or the liquid is very acidic. Factors such as temperature and flow rate affect the rate at which the corrosion occurs.

### Preventing Oxidation

Oxidation results when oxygen dissolved in the water reacts with the iron to form ferric hydroxide (rust). When a closed hydronic system is filled with fresh water, oxidation occurs until the oxygen is consumed. It is important to prevent new oxygen from entering the system and continuing the oxidation process. The most common sources of oxygen include oxygen diffusion through pipe materials and the continuous addition of make up water due to leakage from the system. Fresh air and oxygen may also enter the system if a negative pressure exists due to an incorrect placement of the pump and expansion tank. If new oxygen cannot be prevented from entering the system, chemical treatments such as oxygen scavengers must be used. It is important to note that the use of chemicals requires periodic maintenance.

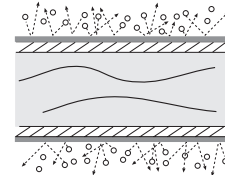

When using plastic pipe, an oxygen diffusion barrier is often available.

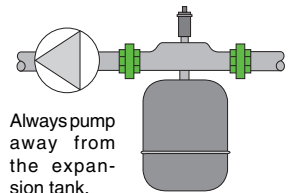

Always pump away from the expansion tank.

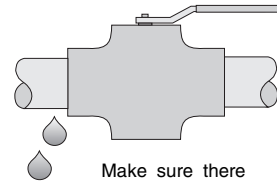

Make sure there are no leaks



If oxygen continues to remain within the system, use an oxygen scavenger.

### Raising the pH Level of the Water

Water with a pH of less than 4.5 (acidic) greatly accelerates the corrosion of iron and steel. One method of reducing corrosion of iron in a closed system is to increase the pH level to produce an alkaline solution. A water treatment specialist should be consulted for more information on the available chemical treatments for adjusting the pH level.

### Reducing Galvanic Corrosion

Galvanic corrosion results when different metals are used in the same piping network. The mixing valve is commonly used in both copper and mild steel (black iron) piping systems. Mild steel pipe does not cause cast iron to corrode and is the recommended piping material for use with the mixing valve. When a small amount of cast iron is placed in a large copper piping network, the cast iron corrodes quickly. Sections of the copper pipe can be replaced with mild steel pipe to reduce the severity of the corrosion. Mild steel generally corrodes more quickly than cast iron and therefore the pipe is sacrificed for the valve. Dielectric unions can also be used to separate ferrous and copper materials in order to reduce corrosion of the iron components.

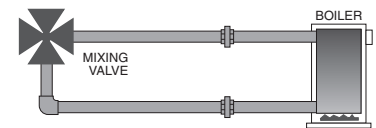

To reduce localized corrosion in the mixing valve, install steel pipe between the boiler and the mixing valve.

### Using a Corrosion Resistant Heat Exchanger

Heat exchangers which have a corrosion resistant liner or which are manufactured from stainless steel can be used to isolate the cast iron mixing valve from corrosive components. The heat exchanger is typically used to separate oxygen permeable pipe or copper pipe from ferrous components. A heat exchanger with a high rate of heat transfer (Btu per hour) is recommended to prevent the valve from oscillating. A plate type heat exchanger is typically used.

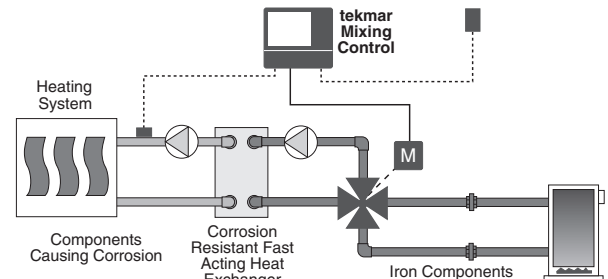

### Adding a Corrosion Inhibitor

A variety of corrosion inhibitors are available which can help prevent corrosion in the system. In systems which require an antifreeze, the corrosion inhibitor may be included as part of the antifreeze solution. For more information, it is best to consult the individual companies who manufacture corrosion inhibitors.

## Parts List

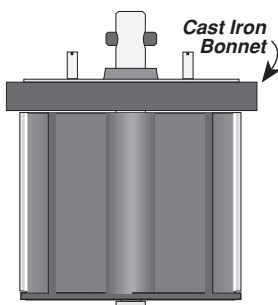

### Valve Flap Assembly (includes bonnet, gasket, 3 x "O" rings, retainer)

- type 016, 1" – Part # M3017
- \* type 017, 1 1/4" – Part # M3018
- \* type 018, 1 1/2" – Part # M3018
- \* type 019, 2" – Part # M3018
- type 024, 2 1/2" – Part # M3019
- type 025, 3" – Part # M3020
- type 026, 4" – Part # M3021

\*Note: M3018 is also available without the cast iron bonnet. Order part# M3030.

### Seal Kit (includes 3 x "O" rings, retainer, gasket)



- type 016, 1" – Part # M3022
- type 017, 1 1/4" – Part # M3022
- type 018, 1 1/2" – Part # M3022
- type 019, 2" – Part # M3022
- type 024, 2 1/2" – Part # M3023
- type 025, 3" – Part # M3024
- type 026, 4" – Part # M3024

### Coupling Kit Part # M3029

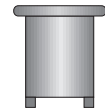

### Valve Handle & Retaining Screw Part # M3025

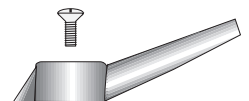

## Technical Data

### 4-Way Mixing Valves 016 — 026

- Literature — D 016
- Maximum operating pressure — 90 psi (600 kPa)
- Operating temperature range — 32°F (0°C) to 230°F (110°C) (for pure water)
- Acceptable fluid media — Chilled and hot water with antifreeze and anticorrosive compounds (max. 60%), glycol, ethyl alcohol glycol, propylene dichloride alcohol, mono ethyl alcohol, ethyl methyl alcohol, glycerine. *Not for media based on mineral oil components.*
- Valve Body — Cast Iron
- Mixing Vane (types 016 to 019) — Glass Fibre Reinforced PPO Plastic  
(type 024 - 026) — Cast Iron
- Shaft and Roller Seals — Stainless Steel
- Seal Springs — Silicon Rubber
- Shaft Seal — EPDM "O" rings
- Standard of Construction — CSA B51-95

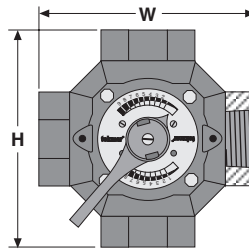

type 016 to 019 — female NPT connections

Valves with female NPT connections

type	Pipe size	CV Value	Net Weight
016	1"	15	7.5 lbs (3.4 kg)
017	1-1/4"	25	10 lbs (4.5 kg)
018	1-1/2"	40	12.7 lbs (5.8 kg)
019	2"	60	16 lbs (7.3 kg)

type	size	Dimension H	Dimension W	Dimension U	Connections
016	1"	5-7/8" (148 mm)	5-7/8" (148 mm)	-	female NPT
017	1-1/4"	6-1/4" (158 mm)	6-1/4" (158 mm)	-	female NPT
018	1-1/2"	7-1/4" (182 mm)	7-1/4" (182 mm)	-	female NPT
019	2"	7-7/8" (198 mm)	7-7/8" (198 mm)	-	female NPT
024	2-1/2"	9-1/2" (234 mm)	9-1/2" (234 mm)	-	ASME
025	3"	10" (254 mm)	10" (254 mm)	-	ASME
026	4"	11-1/2" (295 mm)	11-1/2" (295 mm)	-	ASME

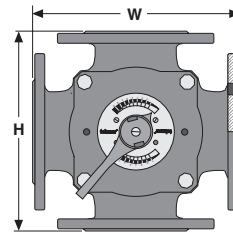

type 024 to 026

Valves using ASME flanges (gaskets, flanges, nuts and bolts not included)

type	Pipe size	CV Value	Net Weight
024	2-1/2"	100	36 lbs (16.5 kg)
025	3"	150	55 lbs (25 kg)
026	4"	210	78 lbs (35 kg)

### Valve Performance Curves

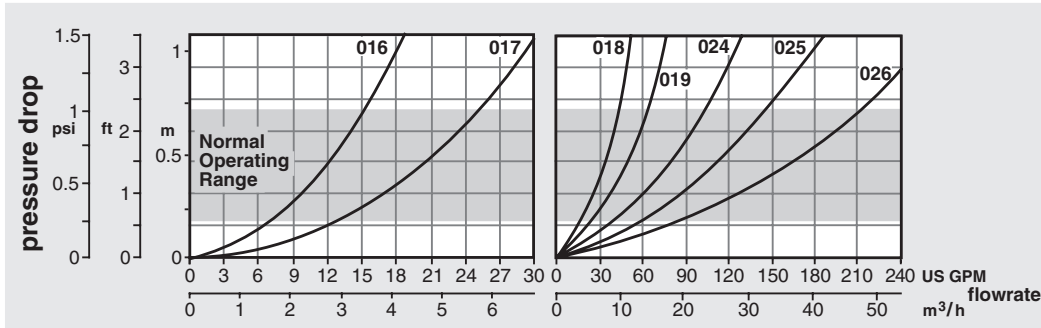

## Limited Warranty and Product Return Procedure

**Limited Warranty** The liability of tekmar Control Systems Ltd. and tekmar Control Systems, Inc. ("tekmar") under this warranty is limited. The purchaser, by taking receipt of the tekmar product ("product"), acknowledges receipt of the terms of the warranty and acknowledges that it has read and understands same.

tekmar warrants each tekmar product against defects in workmanship and materials, if the product is installed and used in compliance with tekmar's instructions. The warranty period is for a period of twenty-four (24) months from the production date if the product is not installed during that period, or twelve (12) months from the documented date of installation if installed within twenty-four (24) months from the production date.

The liability of tekmar under this warranty shall be limited to, at tekmar's sole discretion: the cost of parts and labor provided by tekmar to repair defects in materials and/or workmanship of the defective product; or to the exchange of the defective product for a replacement product; or to the granting of credit limited to the original cost of the defective product, and such repair, exchange or credit shall be the sole remedy available from tekmar, and, without limiting the foregoing in any way, tekmar is not responsible, in contract, tort or strict product liability, for any other losses, costs, expenses, inconveniences, or damages, whether direct, indirect, special, secondary, incidental or consequential, arising from ownership or use of the product, or from defects in workmanship or materials, including any liability for fundamental breach of contract.

**This warranty applies only to those products returned to tekmar during the warranty period. This warranty does not cover the cost of the parts or labor to remove or transport the defective product, or to reinstall the repaired or re-**

**placement product. Returned products that are not defective are not covered by this warranty.**

This warranty does not apply if the product has been damaged by negligence by persons other than tekmar, accident, fire, Act of God, abuse or misuse; or has been damaged by modifications, alterations or attachments made subsequent to purchase which have not been authorized by tekmar; or if the product was not installed in compliance with tekmar's instructions and the local codes and ordinances; or if due to defective installation of the product; or if the product was not used in compliance with tekmar's instructions.

This warranty is in lieu of all other warranties, express or implied, which the Governing Law (being the law of British Columbia) allows parties to contractually exclude, including, without limitation, warranties of merchantability, fitness for a particular purpose, durability or description of the product, its non-infringement of any relevant patents or trademarks, and its compliance with or non-violation of any applicable environmental, health or safety legislation; the term of any other warranty not hereby contractually excluded is limited such that it shall not extend beyond twenty-four (24) months from the production date, to the extent that such limitation is allowed by the Governing Law.

**Product Return Procedure** Products that are believed to have defects in workmanship or materials must be returned, together with a written description of the defect, to the tekmar representative for that territory. If the address of the representative is not known, please request it from tekmar at the telephone number listed below.



tekmar Control Systems Ltd., Canada  
tekmar Control Systems, Inc., U.S.A.  
Head Office: 5100 Silver Star Road  
Vernon, B.C. Canada V1B 3K4  
Tel. (250) 545-7749 Fax. (250) 545-0650  
Web Site: [www.tekmarcontrols.com](http://www.tekmarcontrols.com)

