



Cascading the

FT SERIES

Floor Standing and Wall-Mounted
Modulating Condensing Gas
Heating Only Boilers

Floor Models: B/LFTHF199

Wall-Mounted Models: B/MFTHW 100, 140, 199

- Natural Gas (NG)
Factory Configuration
- Propane Gas (LP)
Field-Convertible

FOR YOUR SAFETY: This product must be installed and serviced by a professional service technician, qualified in hot water boiler and heater installation and maintenance. Improper installation and/or operation could create carbon monoxide gas in flue gases which could cause serious injury, property damage, or death. Improper installation and/or operation will void the warranty.

⚠ WARNING

If the information in this manual is not followed exactly, a fire or explosion may result causing property damage, personal injury or loss of life.

Do not store or use gasoline or other flammable vapors and liquids in the vicinity of this or any other appliance.

WHAT TO DO IF YOU SMELL GAS

- Do not try to light any appliance.
- Do not touch any electrical switch; do not use any phone in your building.
- Immediately call your gas supplier from a nearby phone. Follow the gas supplier's instructions.
- If you cannot reach your gas supplier, call the fire department.

Installation and service must be performed by a qualified installer, service agency, or gas supplier.

⚠ AVERTISSEMENT

Assurez-vous de bien suivre les instructions données dans cette notice pour réduire au minimum le risque d'incendie ou d'explosion ou pour éviter tout dommage matériel, toute blessure ou la mort.

Ne pas entreposer ni utiliser d'essence ou ni d'autres vapeurs ou liquides inflammables dans le à proximité de cet appareil ou de tout autre appareil.

QUE FAIRE SI VOUS SENTEZ UNE ODEUR DE GAZ:

- Ne pas tenter d'allumer d'appareils.
- Ne touchez à aucun interrupteur. Ne pas vous servir des téléphones dans le bâtiment où vous vous trouvez.
- Appelez immédiatement votre fournisseur de gaz depuis un voisin. Suivez les instructions du fournisseur.
- Si vous ne pouvez rejoindre le fournisseur de gaz, appelez le service des incendies.

L'installation et l'entretien doivent être assurés par un installateur ou un service d'entretien qualifié ou par le fournisseur de gaz.

Table of Contents

SECTION 1 General Information.3

1.A General Plumbing Connection Guidelines 3

1.B Pipe Sizing for system and common supply
 & return headers in Cascade Systems..... 3

1.C Product Flow Paths and Characteristics 4

1.C.1 Floor Standing CH Circulation 4

1.C.2 Wall-Mounted CH Circulation 5

1.D High Voltage and Low Voltage Terminals
 (wall and floor models)..... 5

1.E Miscellaneous Wiring 6

SECTION 2 Piping and Wiring Diagrams.8

2.A Cascade FT Floor Heating Only Boilers Piping
 and Wiring Diagrams 8

2.B Cascade FT Wall-Mounted Heating Only Boilers Piping..... 18

**SECTION 3 Cascade Communications
 (the cascade cable).....22**

3.A Cascade Kit Content and Instructions 22

3.B Wiring Connections for Cascade 22

SECTION 4 The Control Display.....26

4.A The Control Display..... 26

4.B The LCD 27

SECTION 5 Cascade Programming.....28

5.A Programming a Cascade System 28

5.B The Cascade CH Function for Set Point Operation..... 29

5.C Outdoor Reset Operation..... 30

5.D Domestic Hot Water 'Storage Mode' for Cascade System. 30

5.E Cascade System Error Codes 32

SECTION 1 General Information.

Multiple FT Series boilers can be connected via a cascade communication cable to create a bank of boilers that work in tandem. Up to 20 boilers can be controlled by a "Leader" FT Series boiler with the others acting as "Followers". **All cascaded boilers must be the same model and size.**

WARNING

Do not use FT Series units on common vents. Each unit must have its own supply and exhaust vents.

1.A General Plumbing Connection Guidelines

- Pipe material must be suitable to meet local codes and industry standards.
- The pipe must be cleaned and without blemish before any connections are made.
- Do not apply a torch within 12" of the bottom connections of the boiler. Doing so could damage the boiler. Such damages ARE NOT covered by product warranty.
- Isolation (shutoff valves) should be used to ease future service.
- All piping should be insulated.
- Pump speeds in Table 1 refer to the internal boiler pump.

1.B Pipe Sizing for system and common supply & return headers in Cascade Systems

CAUTION

Use piping diameters as per Tables 1 - 3 based on your maximum design delta T. Non-adherence to these sizing guidelines may result in premature boiler failure and resulting problems are NOT covered by product warranty.

Use both thread tape and pipe dope to connect to the 1¼" or 1½" CH supply and return.

Table 1: Common Pipe Sizing for $\Delta T = 25$ F (Speed 3 - default)

Model/# of units	1	2	3	4	5	6	7	8
100	1"	1-1/2"	2	2	2-1/2"	2-1/2"	3	3
140	1-1/4"	2	2	2-1/2"	2-1/2"	3	3	4
199	1-1/4"	2	2-1/2"	3	3	4	4	4

Table 2: Common Pipe Sizing for $\Delta T = 35$ F (Speed 2)

Model/# of units	1	2	3	4	5	6	7	8
100	1"	1-1/4"	1-1/2"	2	2	2	2-1/2"	2-1/2"
140	1"	1-1/2"	2	2	2-1/2"	2-1/2"	2-1/2"	3"
199	1-1/4"	2	2	2-1/2"	2-1/2"	3	3	4"

Table 3: Common Pipe Sizing for $\Delta T = 45$ F (Speed 1)

Model/# of units	1	2	3	4	5	6	7	8
100	3/4"	1"	1-1/4"	1-1/2"	2	2	2	2
140	1"	1-1/4"	1-1/2"	2	2	2	2-1/2"	2-1/2"
199	1"	1-1/2"	2	2	2-1/2"	2-1/2"	3	3

Notes: For FT Floor boilers, use 1-1/4" near boiler piping with a combined equivalent length not to exceed 15 ft to the supply & return headers. Use 1-1/2" piping for longer runs.

Refer to page 8 of the FT Floor Installation and Operating Manual to set the internal valves as follows for cascade operation: V1 and V3: closed, V2 open. (See next page)

An optional purge station is not needed for FT Floor models if the system piping is above the boilers.

FT Piping Manifolds should NOT be utilized in wall-mounted multi-boiler cascade systems.

1.C Product Flow Paths and Characteristics

1.C.1 Floor Standing CH Circulation

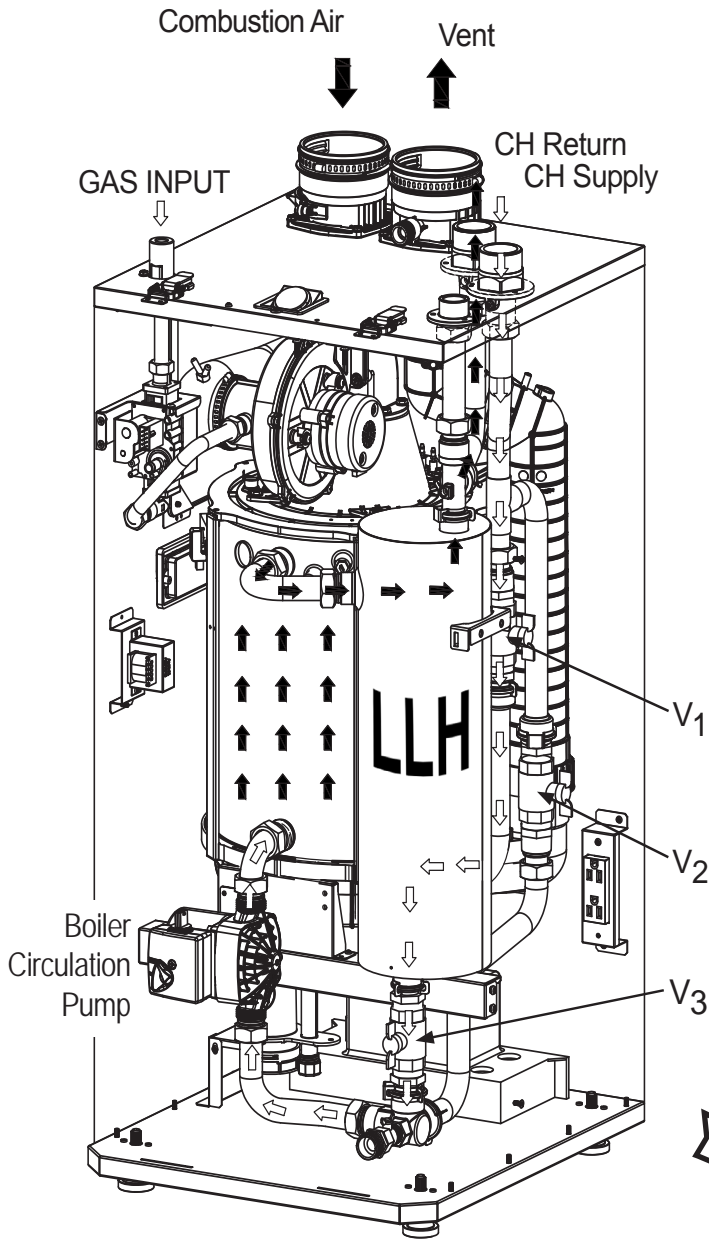

Figure 1. Floor model CH circulation with LLH.

The floor standing models have a built in low loss header.

The boiler circulation pump circulates the CH water in the boilers contained loop from heat exchanger to the low loss header (LLH) and back. The heating system pump or individual zone pumps are required to pull heated water from CH supply connection and return water to the CH return connection.

Max Amp draw per pump = 1.6 Amps.

Factory default valve position:
V1 and V3 open, V2 closed (single boiler).

For cascade operation with boiler pump:
Close V1 and V3. Open V2.

The floor model FT has these additional -----

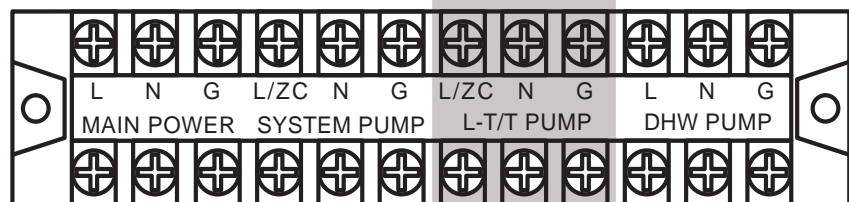

Line Voltage Terminals

1.C.2 Wall-Mounted CH Circulation

The wall-mounted models do NOT have a built-in low loss header.

The boiler circulation pump circulates the CH water out the common header up to 15' of equivalent pipe at 1.5" diameter pipe.

Max Amp draw per pump = 1.6 Amps.

1.D High Voltage and Low Voltage Terminals

NOTE: The terminal blocks are NOT the same on the floorstanding VS the wall-mounted models!

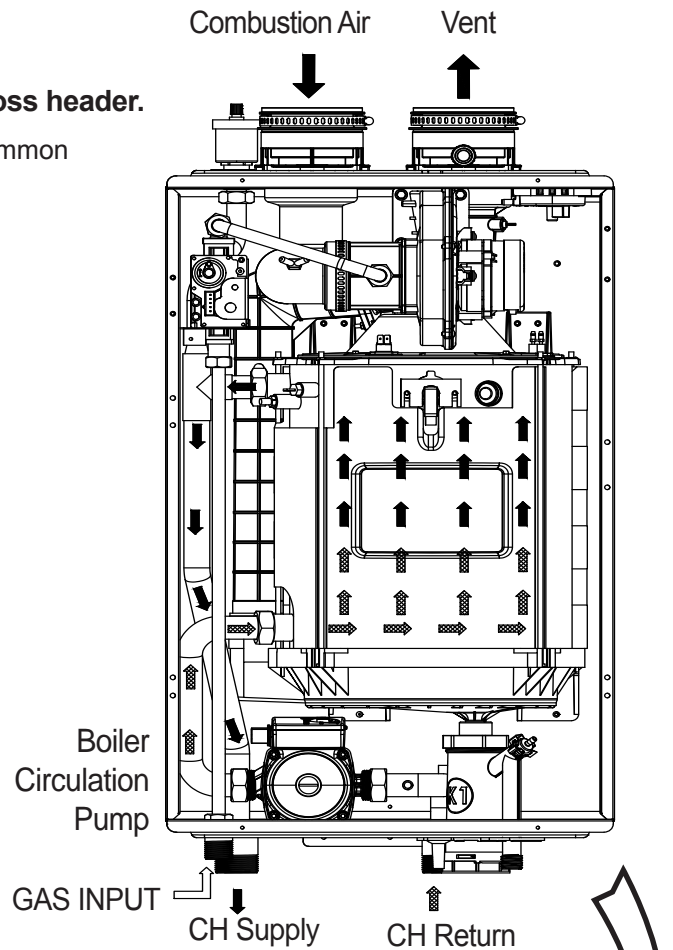
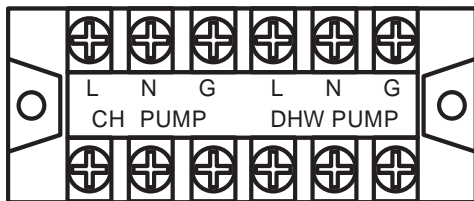
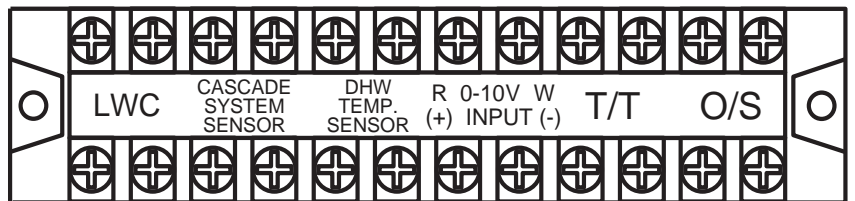

Figure 2. Wall-Mounted CH circulation

WALL MODELS



Line Voltage Terminals



Low Voltage Terminals

Figure 3. Field Connections for WALL models

----- voltage connections / functionalities

FLOOR MODELS

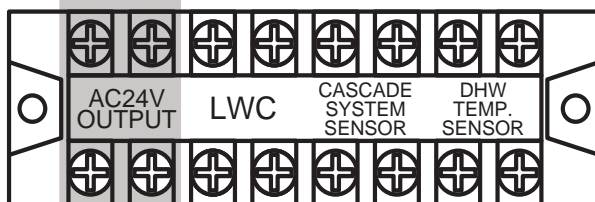

Low Voltage Terminals

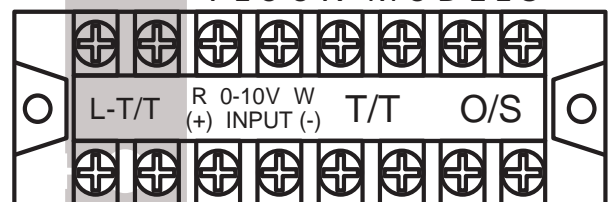

Low Voltage Terminals

Figure 4. Field Connections for FLOOR models

1.E Miscellaneous Wiring

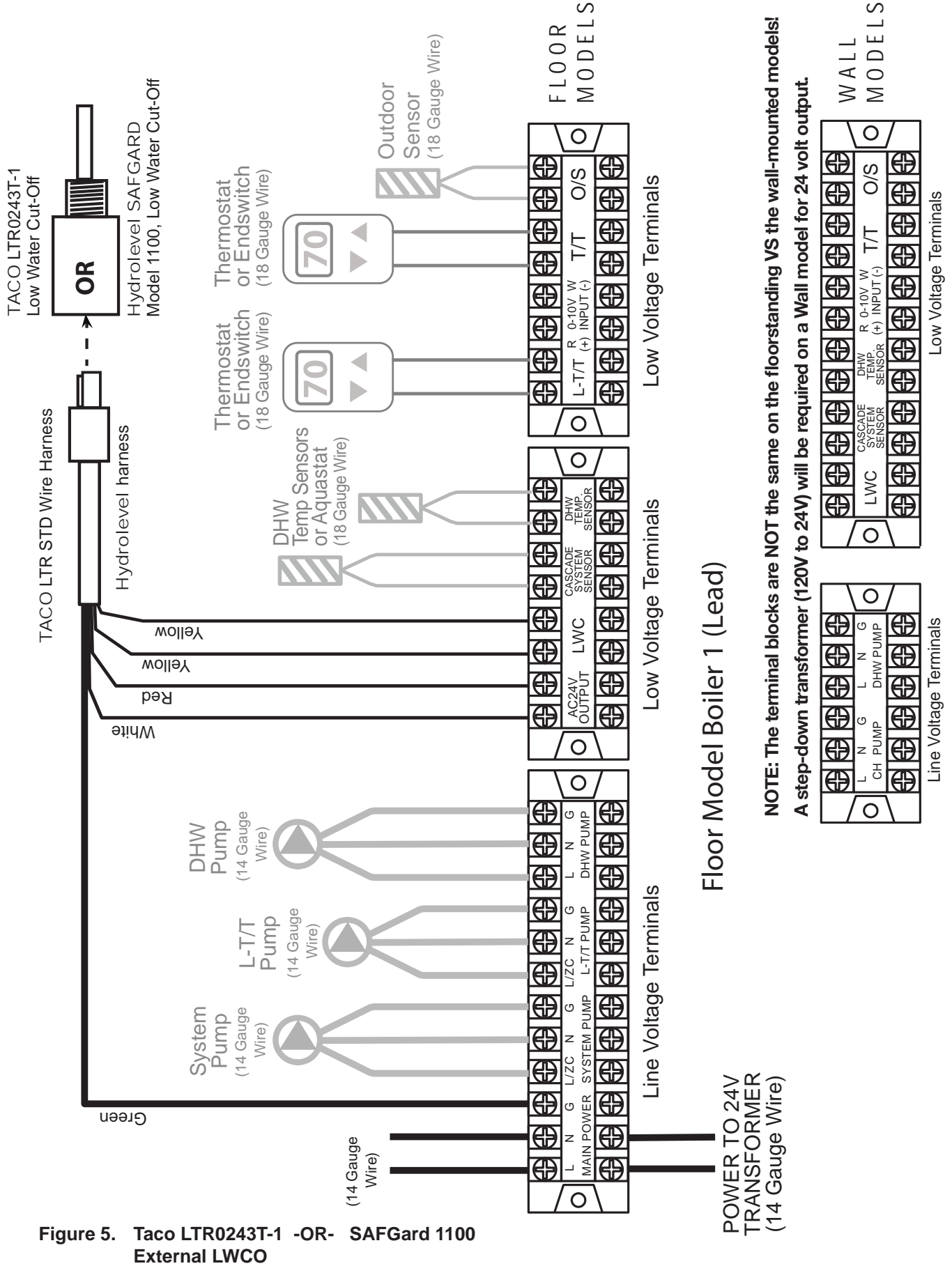

Figure 5. Taco LTR0243T-1 -OR- SAFGard 1100 External LWCO

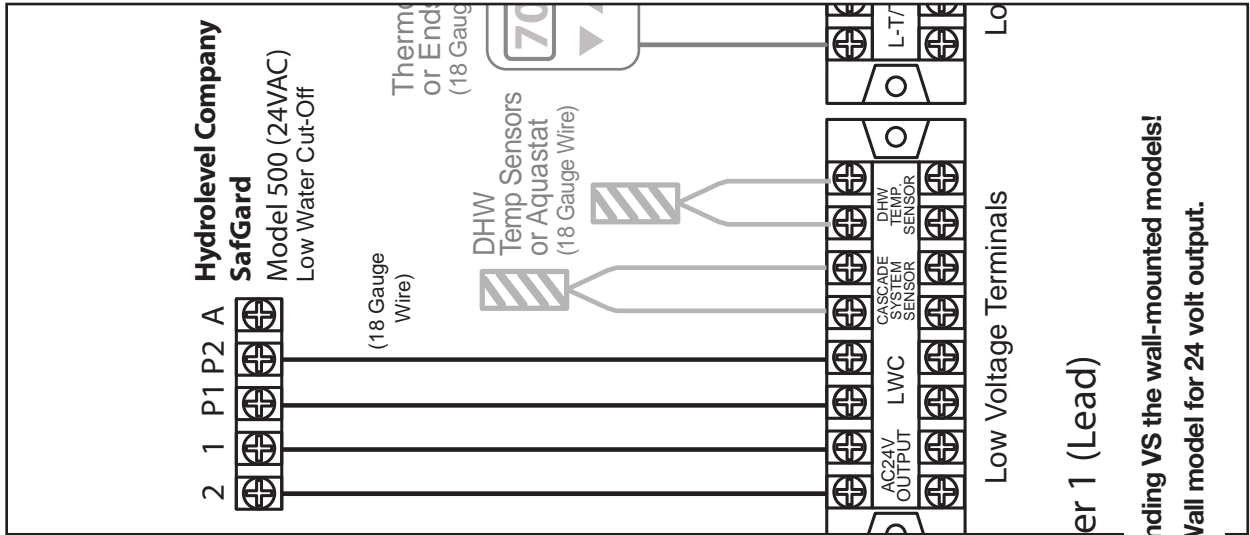

Figure 6. SAFGard 500 External LWCO

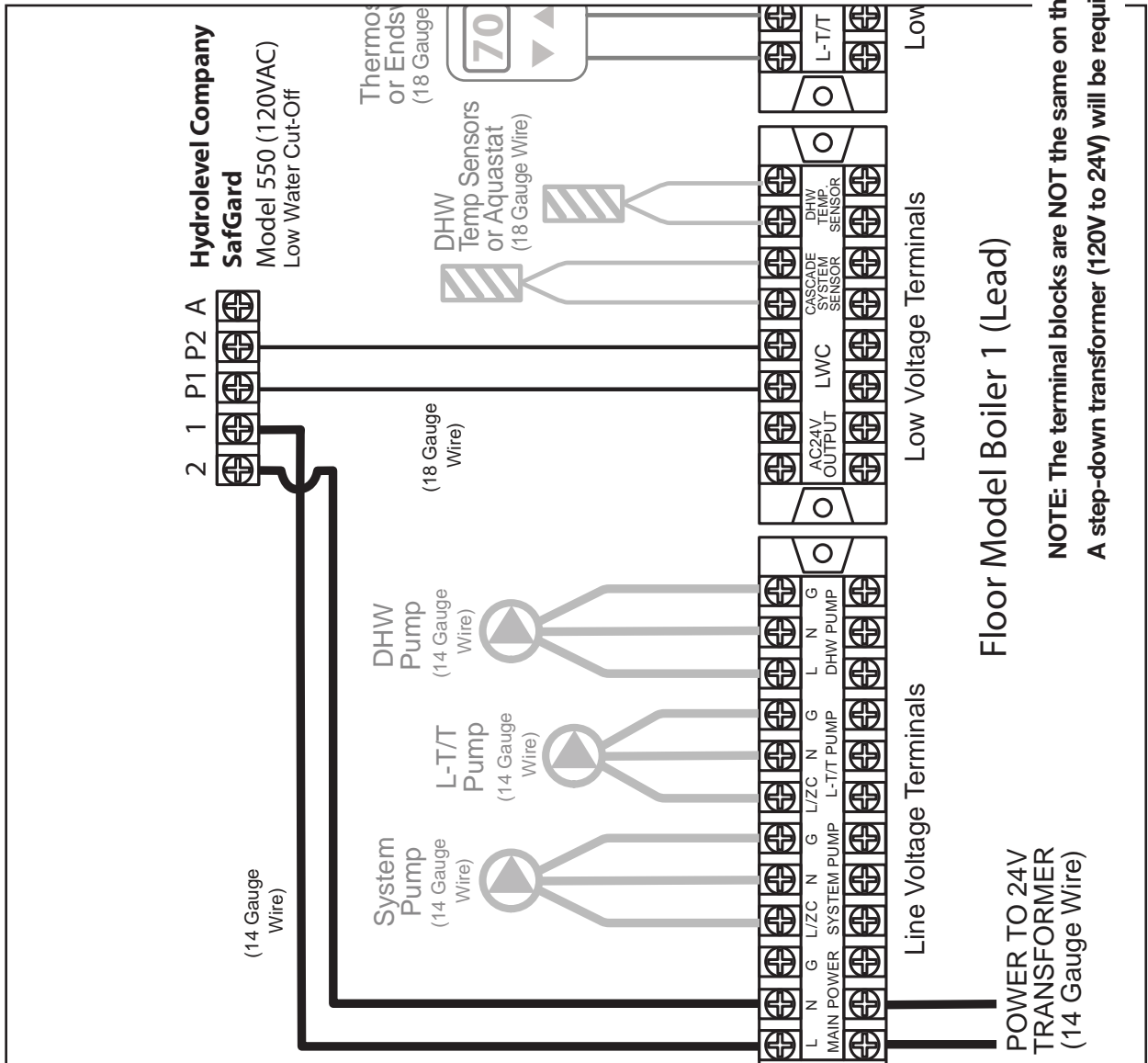
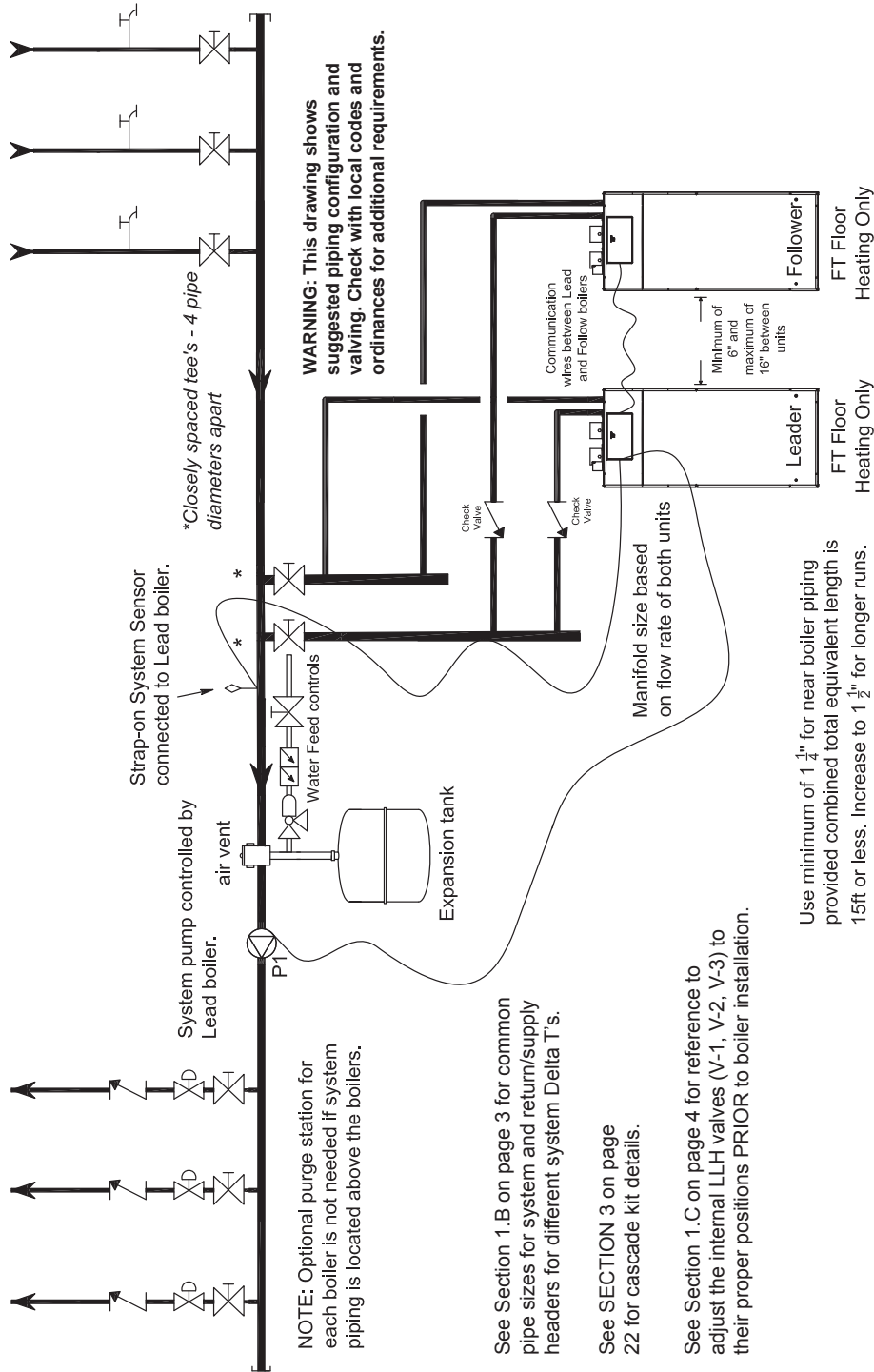

Figure 7. SAFGard 550 External LWCO

NOTE: The terminal blocks are NOT the same on the floorstanding VS the wall-mounted models! A step-down transformer (120V to 24V) will be required on a Wall model for 24 volt output.

SECTION 2 Piping and Wiring Diagrams

2.A Cascade FT Floor Heating Only Boilers Piping and Wiring Diagrams



Expansion tank	
Automatic Air Vent	
Air Separator	
Circulation pump with built in IFR	
Check Valve	
Drain Valve	
Shut-off Valve	
Backflow preventer	
Pressure Relief Valve	
Anti-scald rated Mixing Valve	
Zone Valve	
Pressure reducing Valve	

Figure 8. Two FT floor heating only models, cascaded reverse return with zone valves.

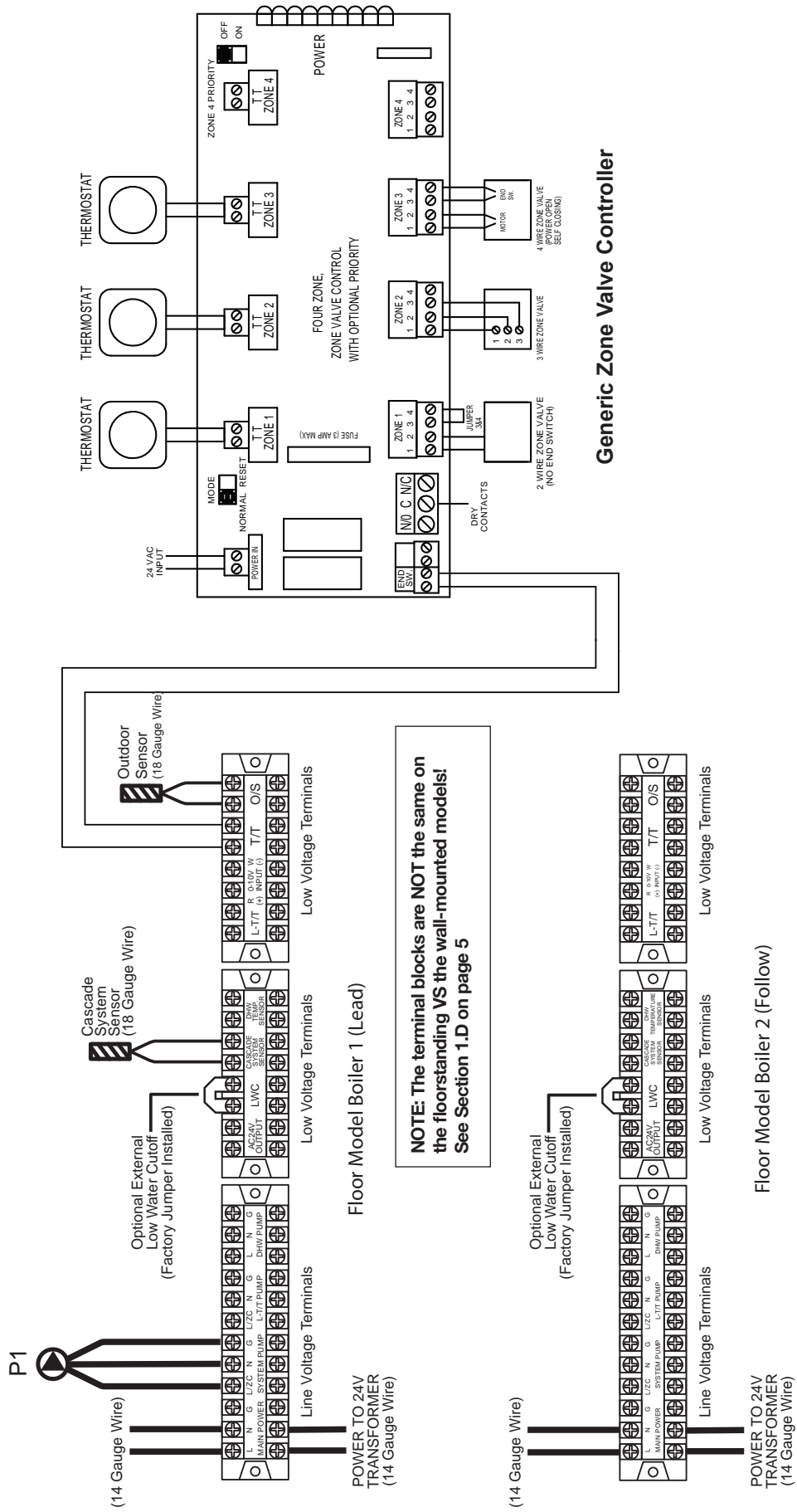

Figure 9. Wiring diagram for cascaded reverse return with zone valves.

Cascade FT Floor Heating Only Boilers Piping and Wiring Diagrams (continued)

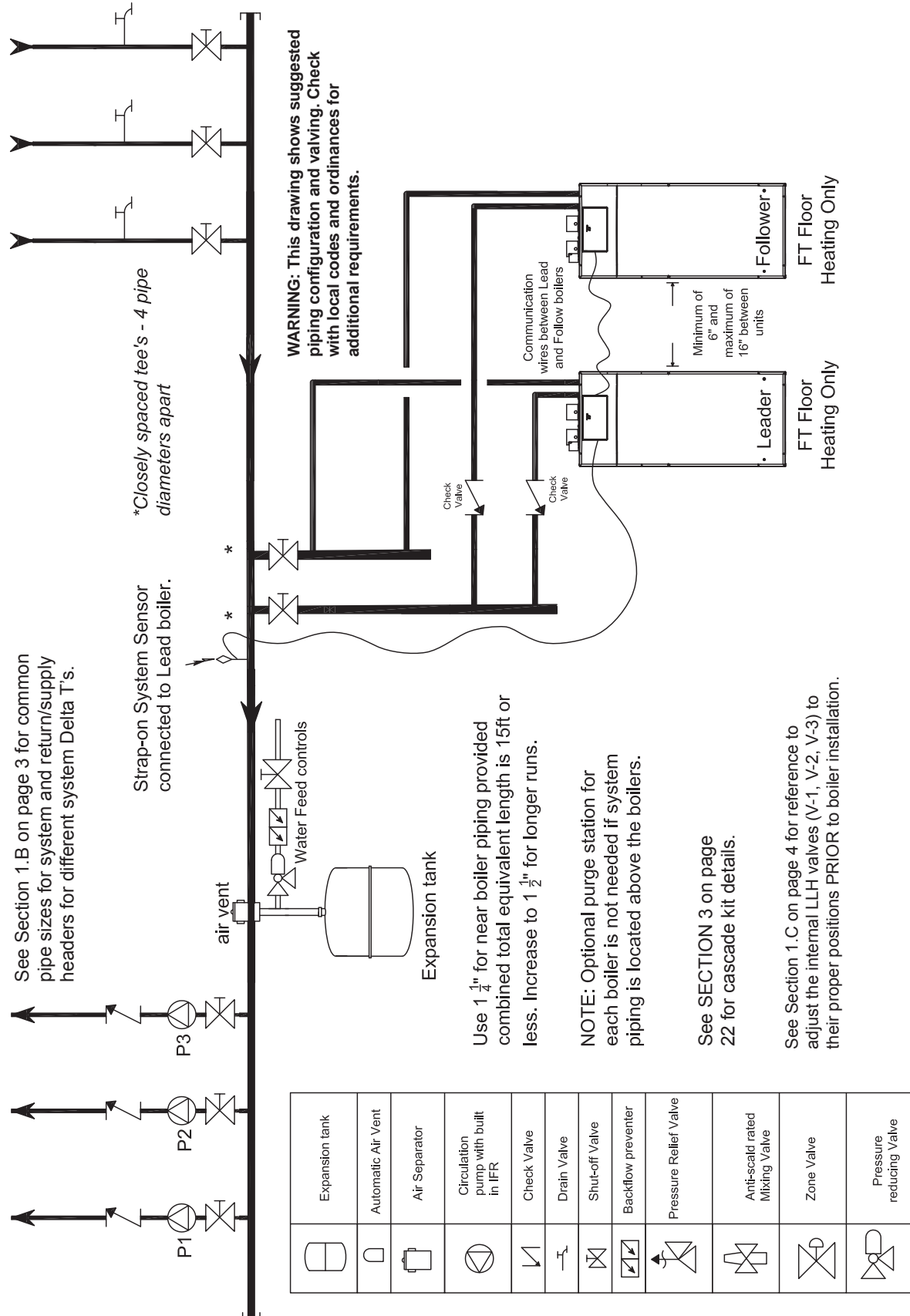
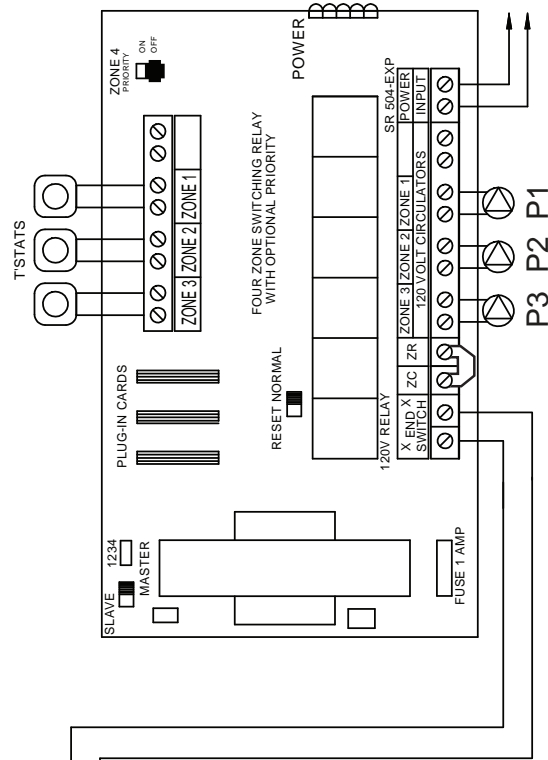
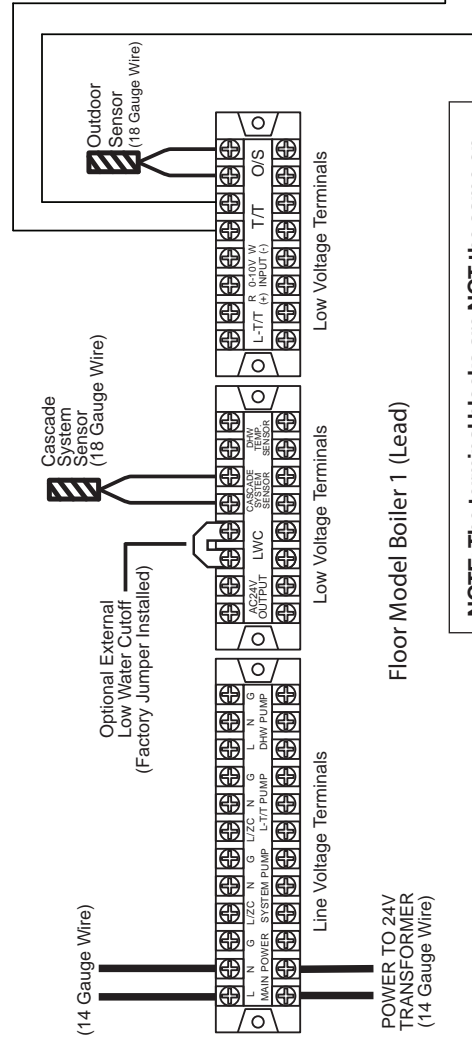

Figure 10. Two FT floor heating only models, cascaded reverse return with zone pumps.



Generic Pump Controller



Floor Model Boiler 1 (Lead)

NOTE: The terminal blocks are NOT the same on the floorstanding VS the wall-mounted models! See Section 1.D on page 5

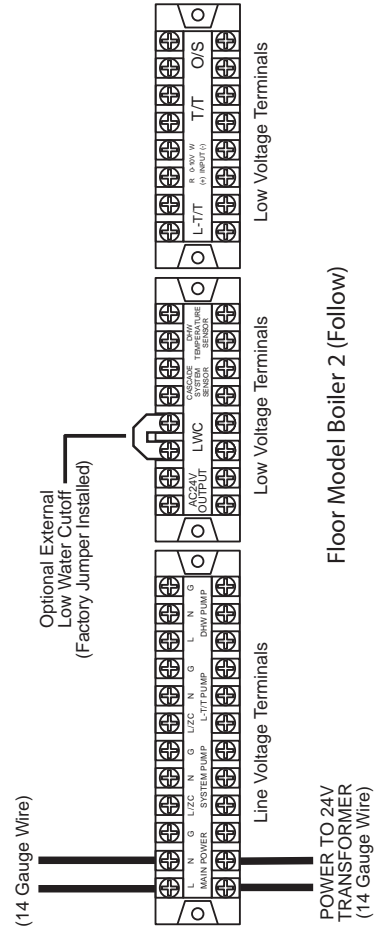

Floor Model Boiler 2 (Follow)

Figure 11. Wiring diagram for cascaded reverse return with zone pumps.

Cascade FT Floor Heating Only Boilers Piping and Wiring Diagrams (continued)

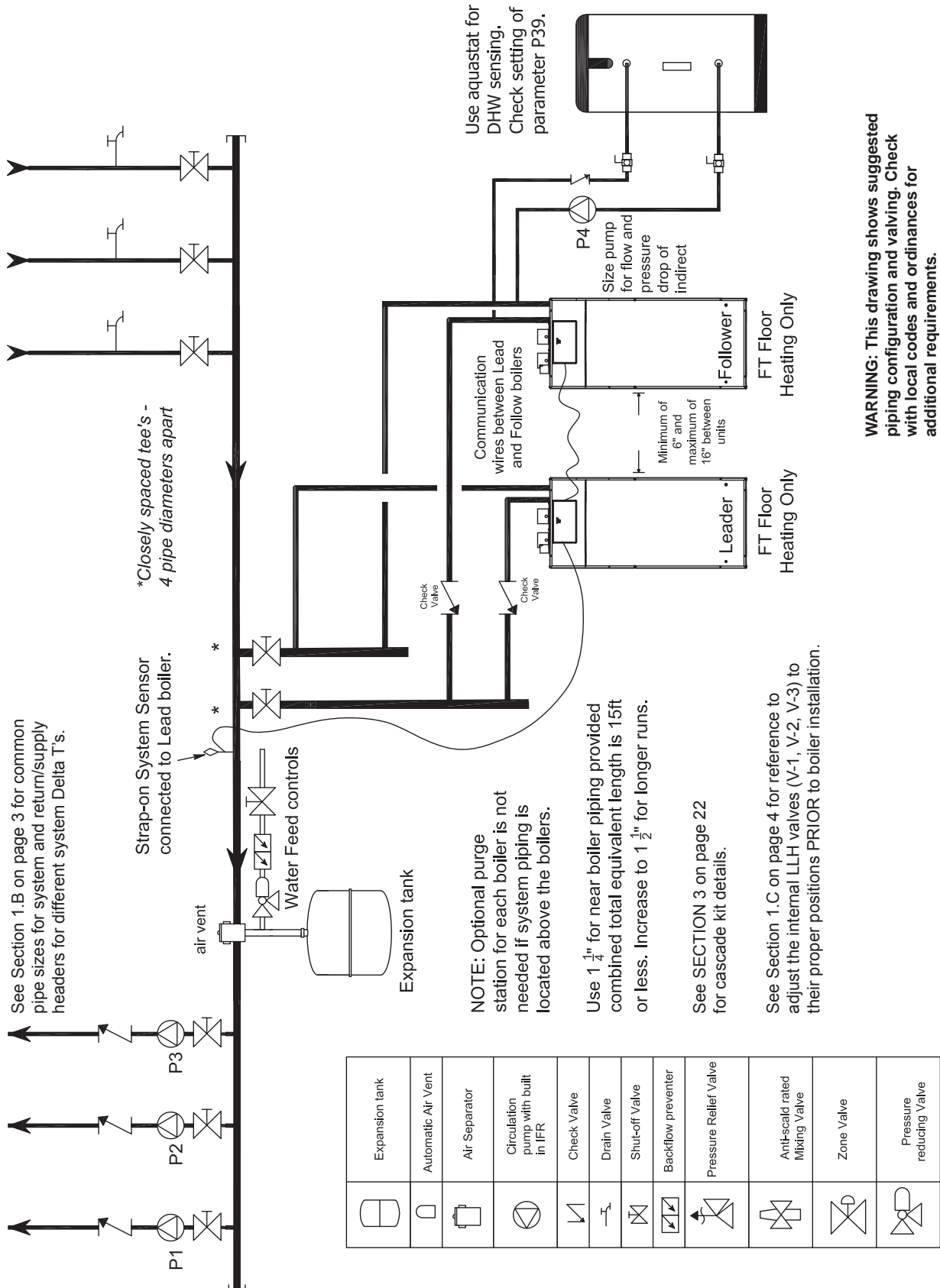

Figure 12. Two FT floor heating only models, cascaded reverse return with pumps and indirect.

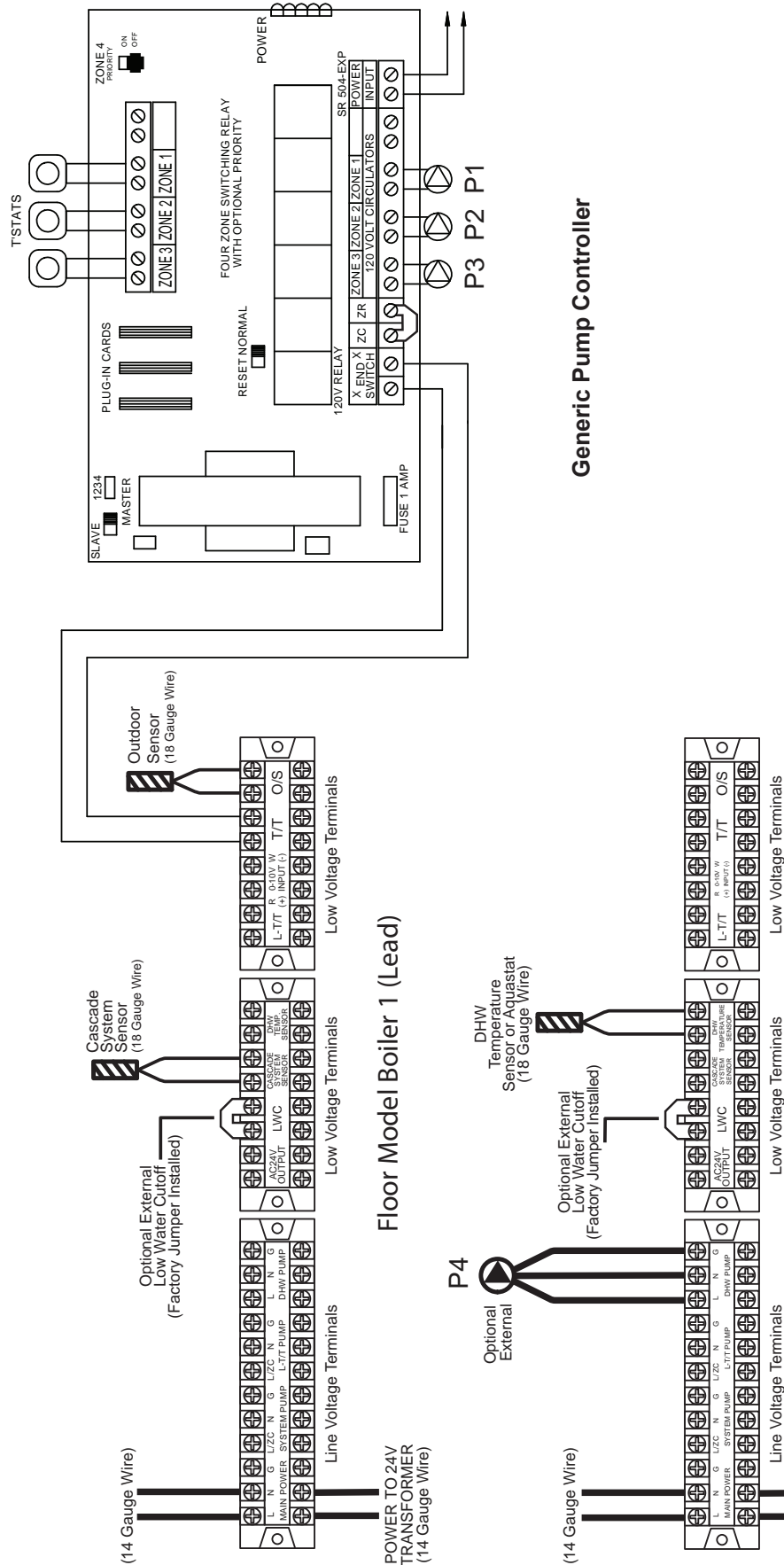
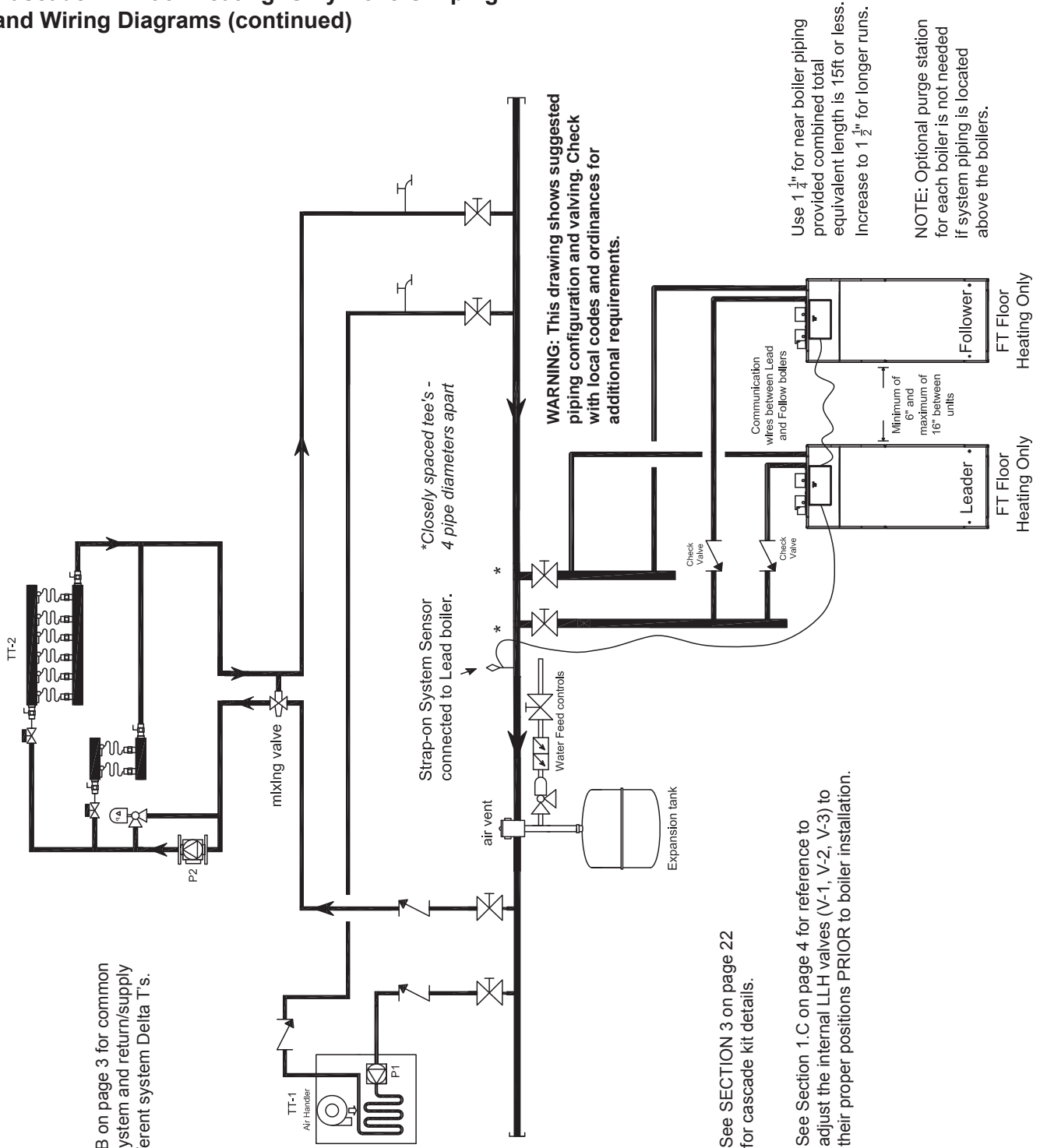

Figure 13. Wiring diagram for cascaded reverse return with system pumps and indirect.

Cascade FT Floor Heating Only Boilers Piping and Wiring Diagrams (continued)



	Expansion tank
	Automatic Air Vent
	Air Separator
	Circulation pump with built in IFR
	Check Valve
	Drain Valve
	Shut-off Valve
	Backflow preventer
	Pressure Relief Valve
	Anti-scald rated Mixing Valve
	Zone Valve
	Pressure reducing Valve

Figure 14. Two FT floor heating only models, cascaded reverse return with low temp zones and air handlers.

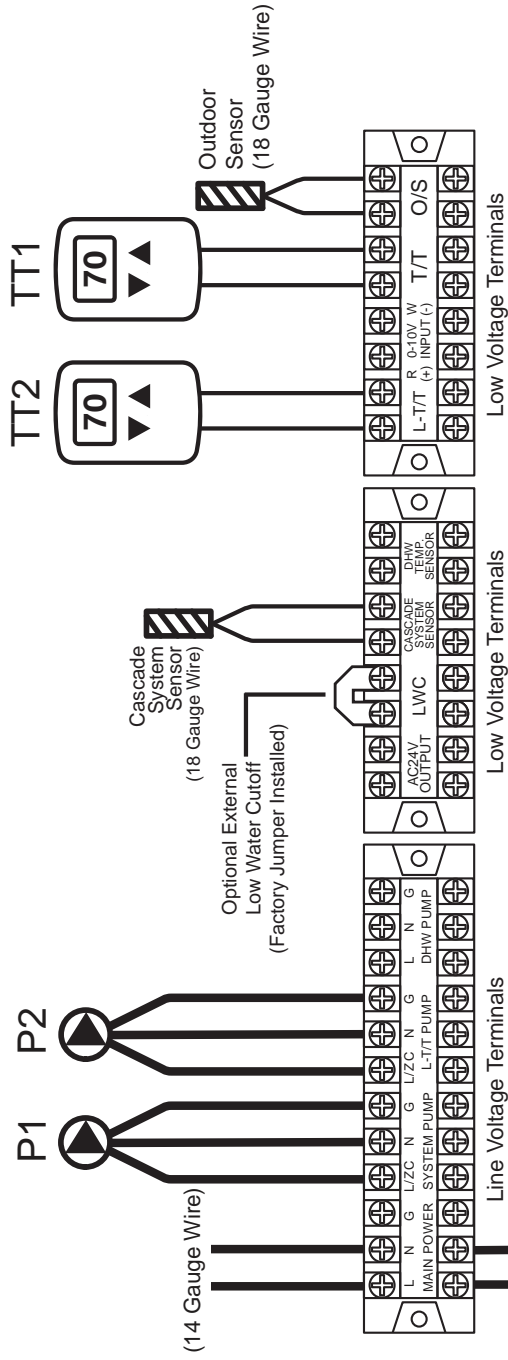

Floor Model Boiler 1 (Lead)

NOTE: The terminal blocks are NOT the same on the floorstanding VS the wall-mounted models! See Section 1.D on page 5

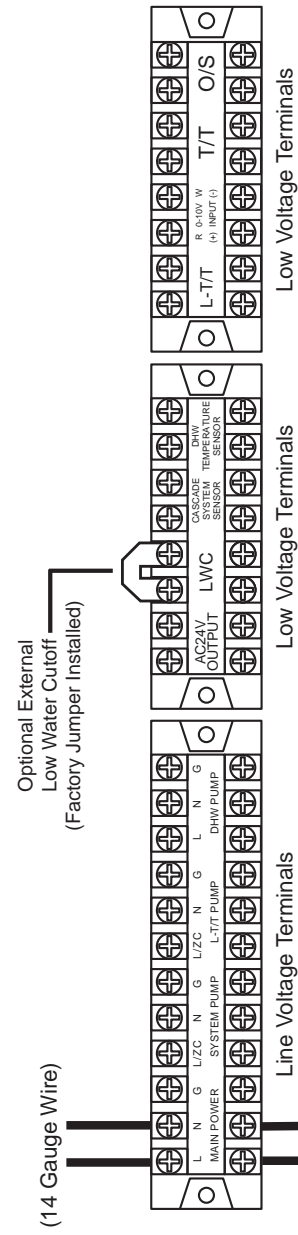

Floor Model Boiler 2 (Follow)

Figure 15. Wiring diagram for cascaded reverse return with low temp zones and air handlers.

Cascade FT Floor Heating Only Boilers Piping and Wiring Diagrams (continued)

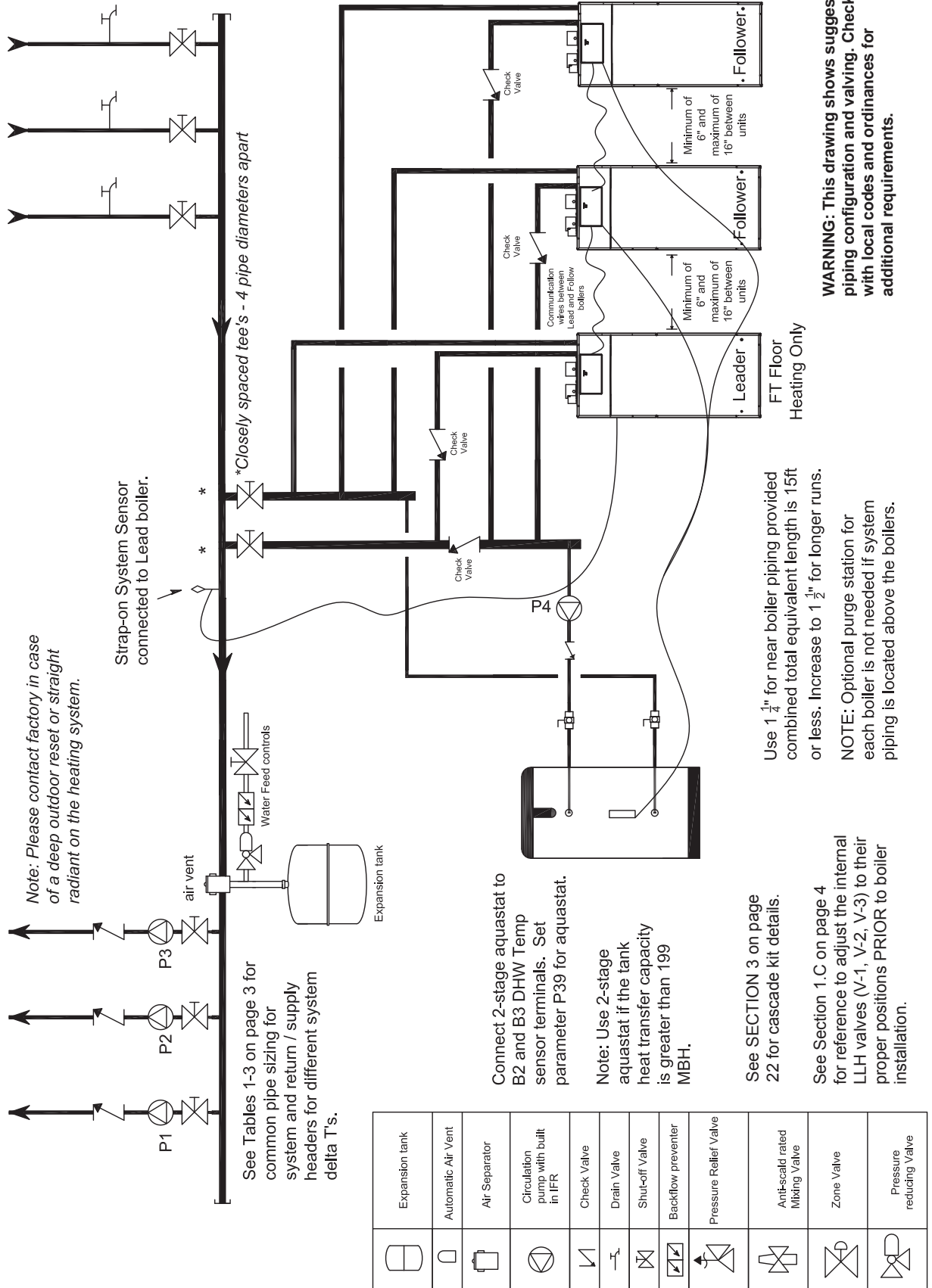

Figure 16. Three FT floor heating only models, cascaded reverse return with zone pumps and indirect.

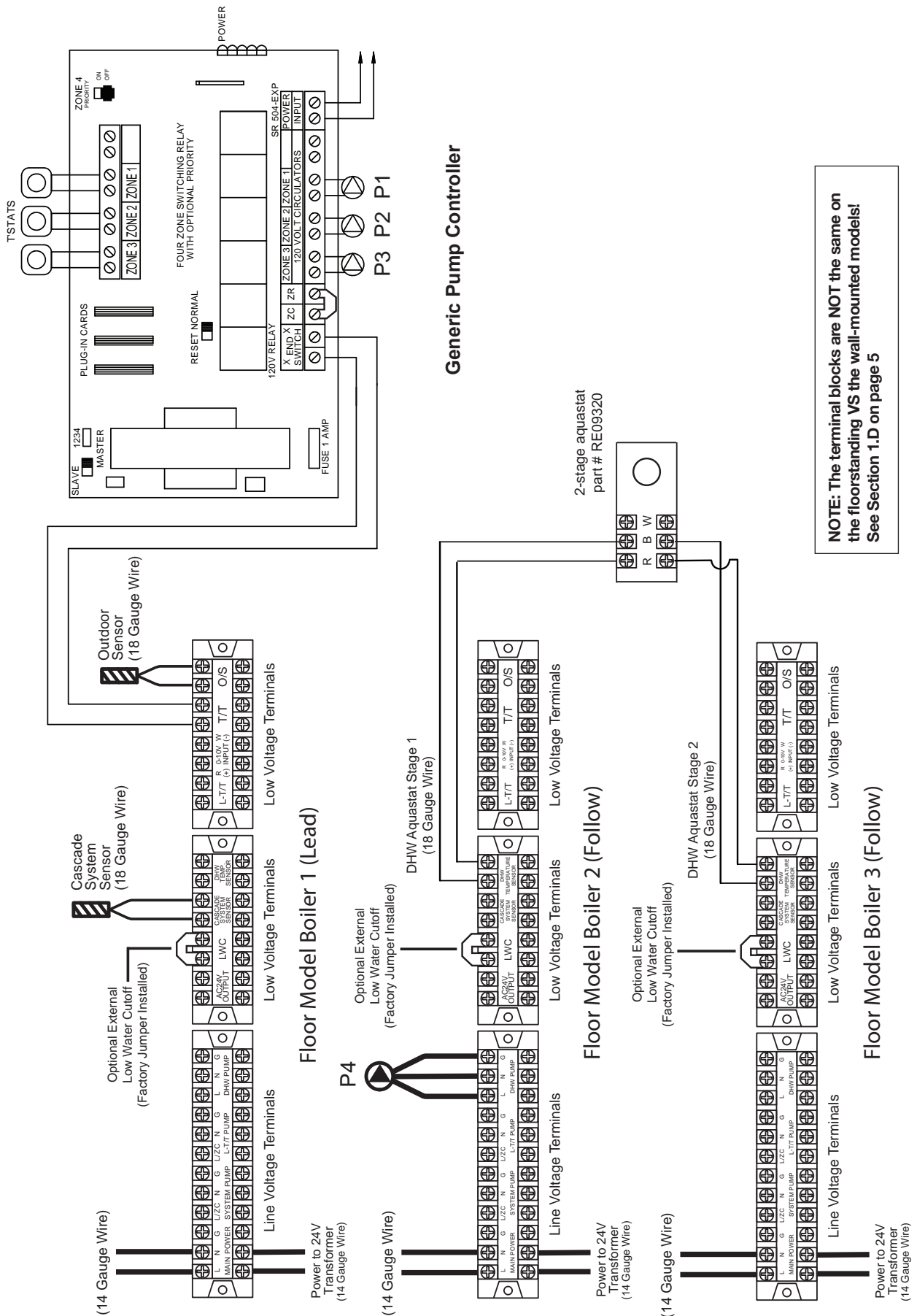
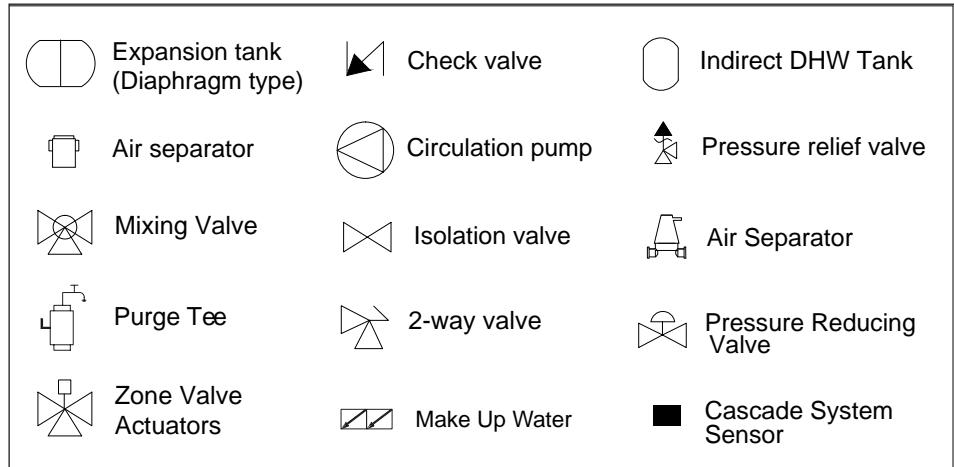

Figure 17. Wiring diagram for cascaded reverse return with zone pumps and indirect.

2.B Cascade FT Wall-Mounted Heating only Boilers Piping



NOTE: These drawings are meant to show system piping concept only. Installer is responsible for all equipment and detailing required by local codes.

NOTE: The cascading communications cable is 60" long. This must be considered during installation as this leaves only about 12" between adjacent units.

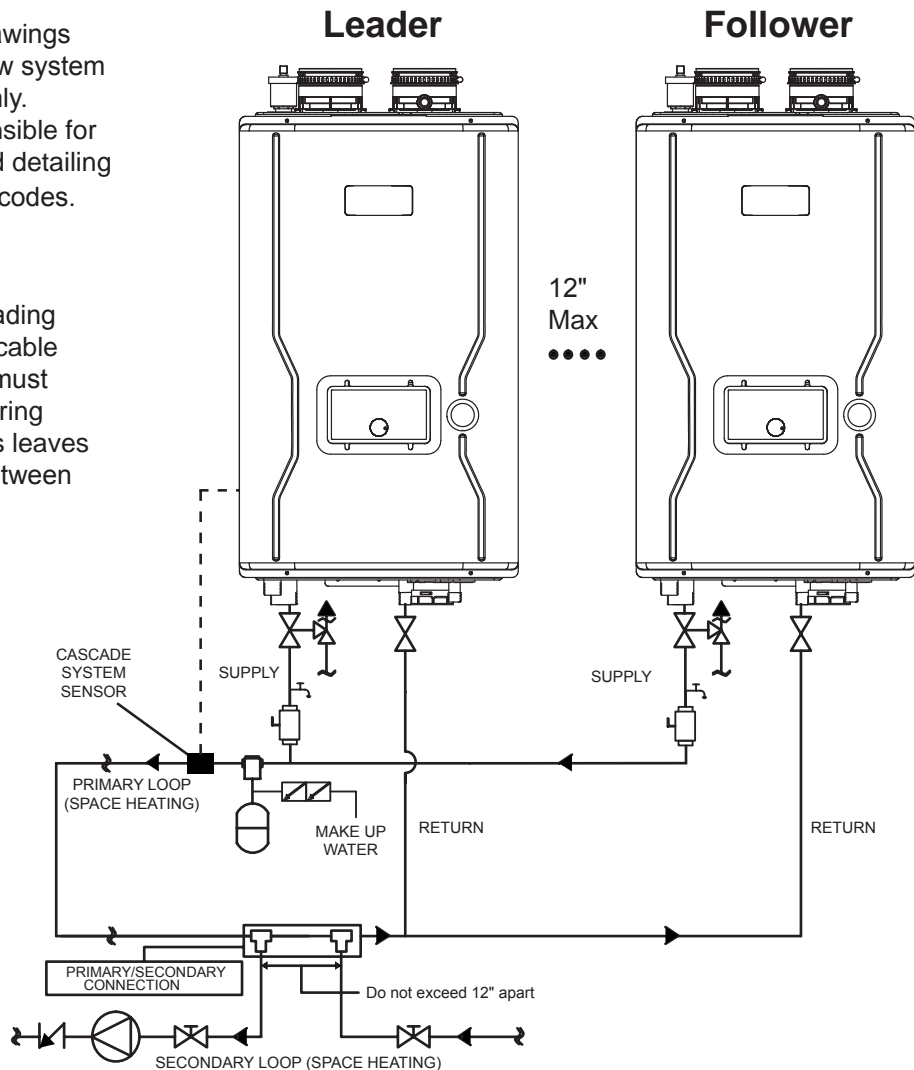

Figure 18. Two FT wall-mounted heating only models, cascaded primary secondary.

NOTE: These drawings are meant to show system piping concept only. Installer is responsible for all equipment and detailing required by local codes.

NOTE: The cascading communications cable is 60" long. This must be considered during installation as this leaves only about 12" between adjacent units.

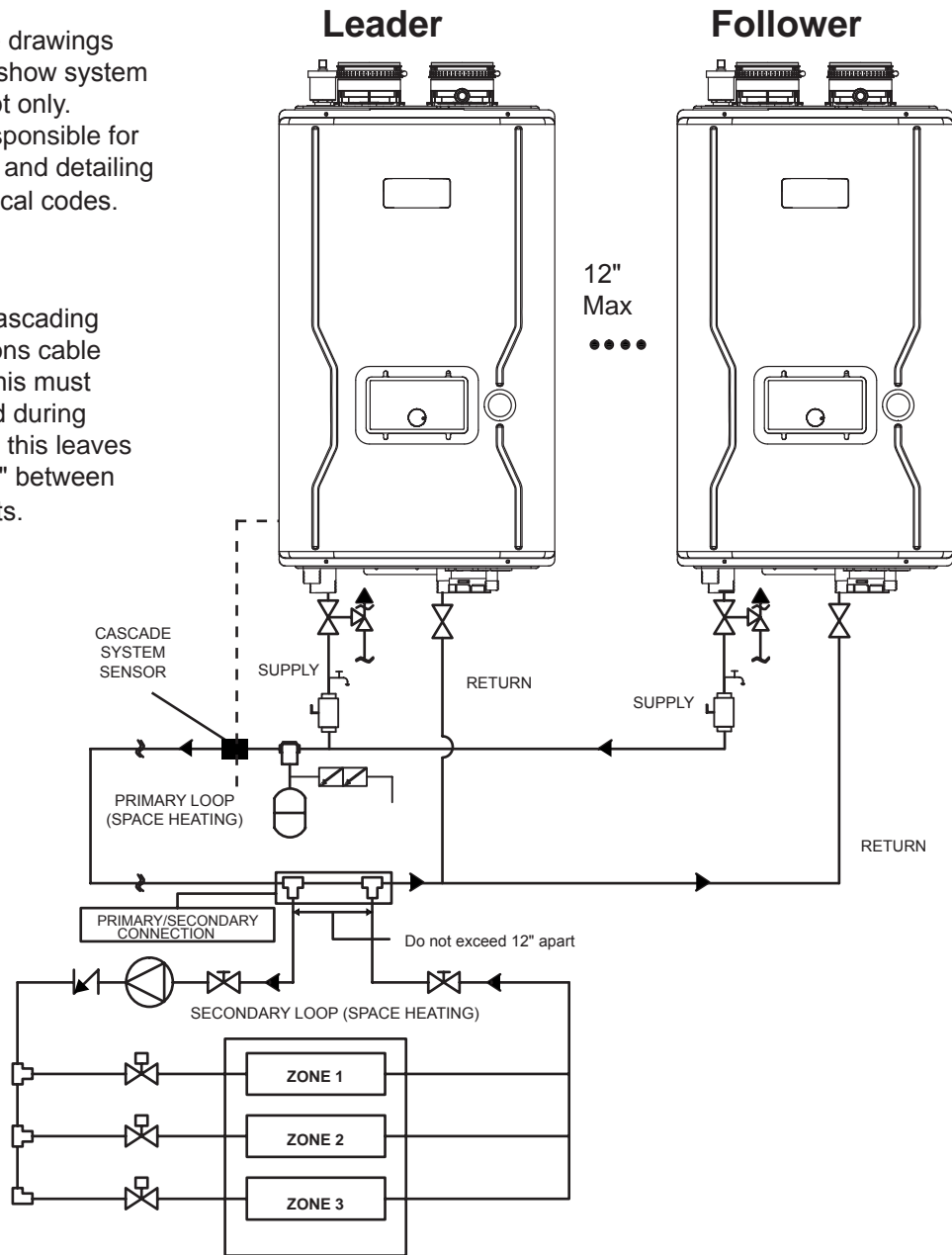
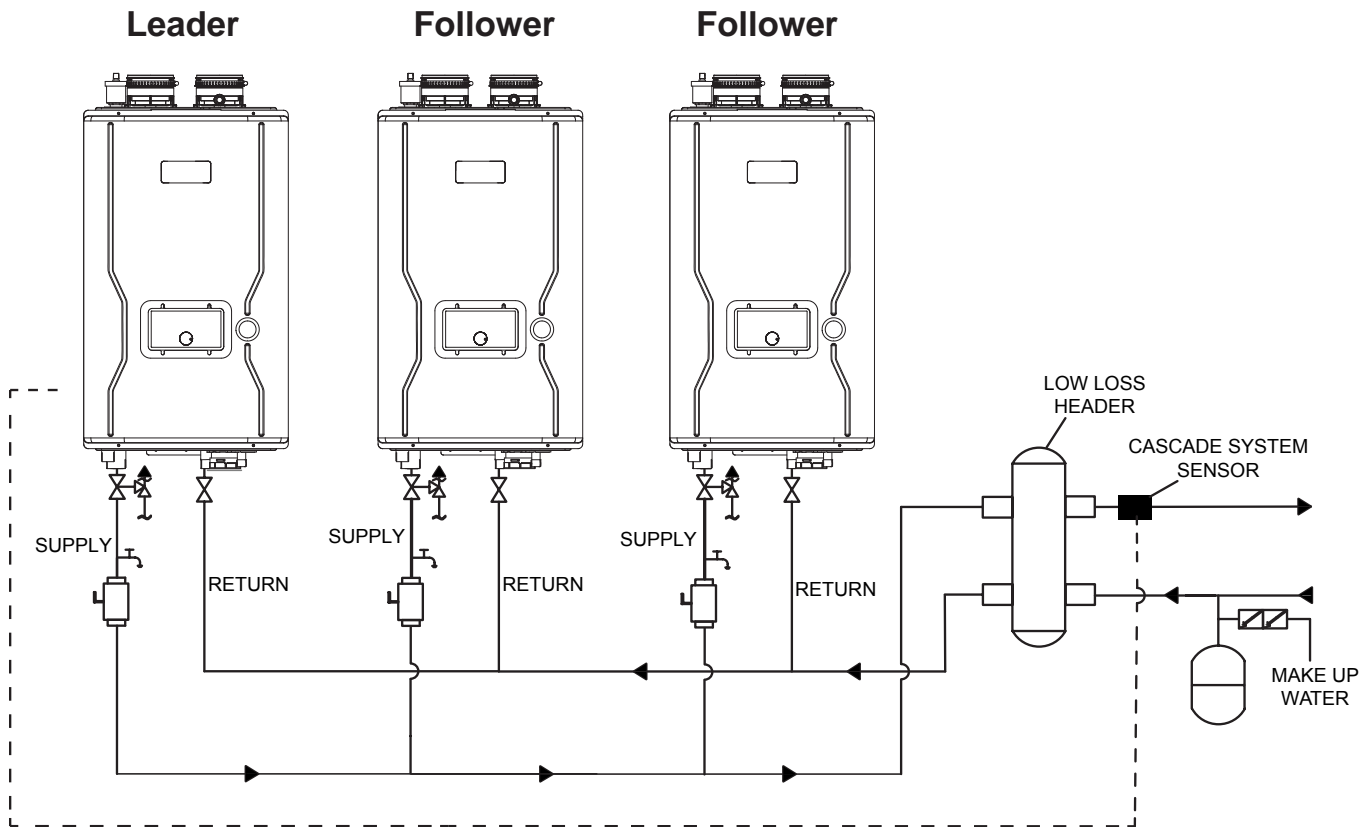
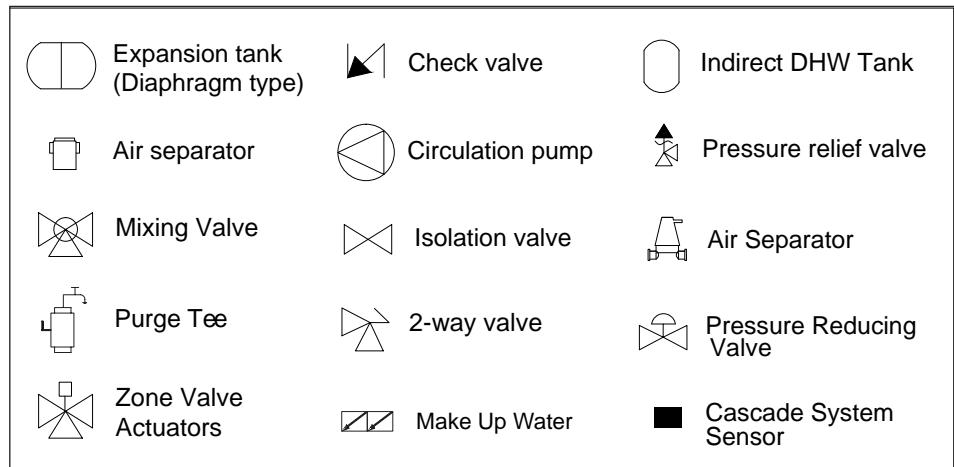

Figure 19. Two FT wall-mounted heating only models, cascaded with zone valves.

Cascade FT Wall-Mounted, Heating Only Boilers Piping Diagrams (continued)



NOTE: These drawings are meant to show system piping concept only. Installer is responsible for all equipment and detailing required by local codes.

NOTE: The cascading communications cable is 60" long. This must be considered during installation as this leaves only about 12" between adjacent units.

Figure 20. Three FT wall-mounted heating only models, cascaded and with low loss header.

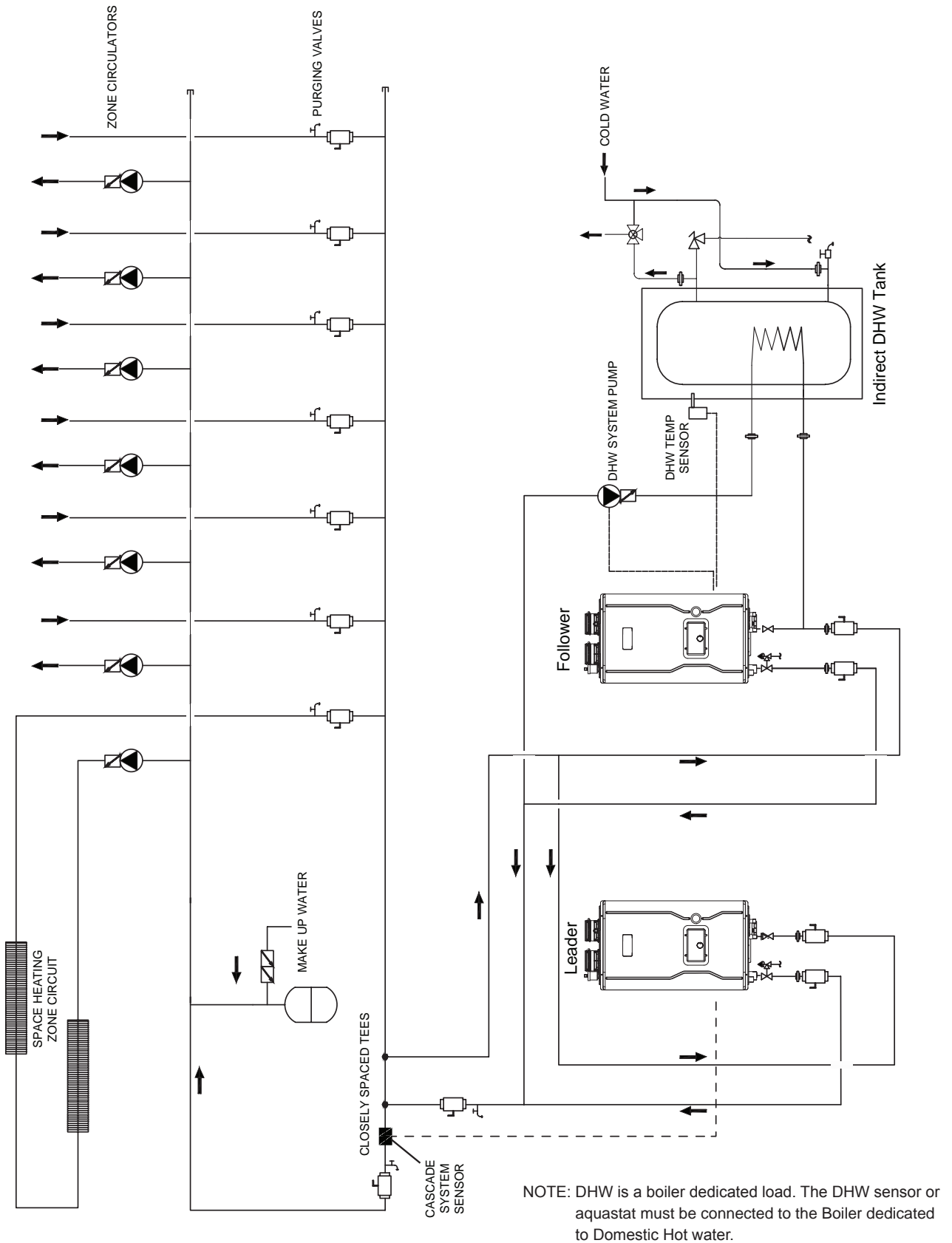

Figure 21. Two FT wall-mounted heating only models, cascaded and with DHW Tank.

SECTION 3 Cascade Communications (cascade cable)

3.A Cascade Kit Content and Instructions

Item #	Description	Part #	CA017502 2 Boilers	CA017503 3 Boilers	CA017504 4 Boilers
1	FT Cascade Instructions	H2384200	1	1	1
2	Cascade System Sensor	FT1868	1	1	1
3	FT Cascade Communication Cable w/ ending resistor	FT1861	2	3	4
4	Cable Tie, Plastic, 4"	E0007501	4	6	8

Table 4: Cascade Kit Components

Notes: Perform start-up and combustion calibration of individual FT boilers BEFORE configuring the cascade system. Refer to Section 4 of the FT Series Heating Only Installation and Operation Instructions for details.

A system sensor must be connected to the leader boiler in order to provide feedback for set point temperature reference and therefore properly control the bank of cascaded boilers.

In order for the system to work properly, the thermostat, 0-10V signal, and/or outdoor sensor must be connected to the leader boiler only. Following boilers will run based on the Leader boiler's controls.

Reference Section 4 of the FT Series Heating Only Installation and Operation manual (Doc #1483 Wall or Doc# 1510 Floor) to set the Leader boiler's temperature set point based on an outdoor sensor, 0-10V signal or a fixed temperature set point and the cascade programming for all units.

Make sure that power is disconnected (OFF) at boiler before continuing with these instructions.

3.B Wiring Connections for Cascade

Components Needed : (included in cascade kit)

FT1868 : System Sensor (need only 1).

FT1861 : FT Series Cascade Communication Cable (1 per unit) with Ending Resistor.

Example. If you are cascading 6 units, you will need **6 X FT1861**'s and you will not use 5 of the resistors.

NOTE: The control boards for the FT Floor and FT wall-mount units are different and can NOT be interchanged.

The FT heating only boilers can be controlled by only the cascade system sensor, either with or without the outdoor sensor.

The cascade system sensor (FT1868) must be connected to the Leader boiler in order to provide feedback for the system set point reference and therefore properly control the cascaded boilers.

Refer back to piping diagrams on page 4 through 19 for the proper location of the cascade sensor. Strap the sensor to the piping and thoroughly insulate the sensor and piping. Connect the sensor leads to terminals marked Cascade System Sensor terminals on the Leader boiler.

If outdoor reset operation is desired, install the outdoor sensor on the northern side of the building away from direct sunlight or other heat sources. Route the control wiring back to the O/S terminals on the Leader boiler. Avoid running this control wiring parallel to 120 V lines.

Cascading the FT Series 'Heating Only' Boiler



Leader Control Board

First Male Connector.

Wrap it up neatly and wire-tie it. It does not need a cap or an end.

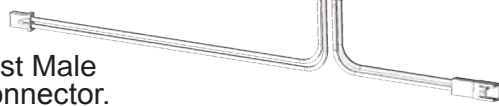

Shown are the control boards of the FT heating only floor units.

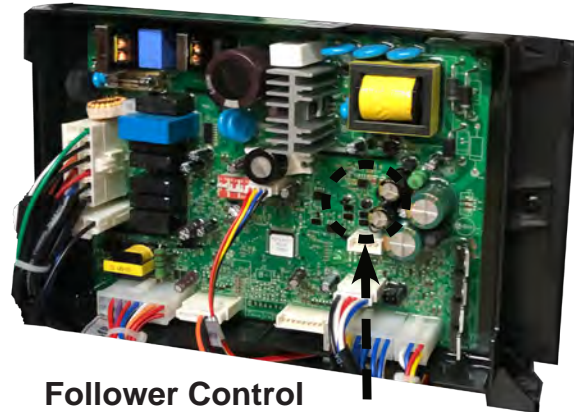

Follower Control Board

Ending Resistor

Last Female Connector.

Plug the included 'Ending Resistor' into it.



Figure 22. Cascade wiring for FT Floor models



Leader Control Board

First Male Connector.

Wrap it up neatly and wire-tie it. It does not need a cap or an end.

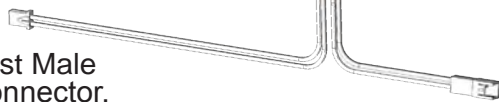

Shown are the control boards of the FT heating only wall-mounted units.

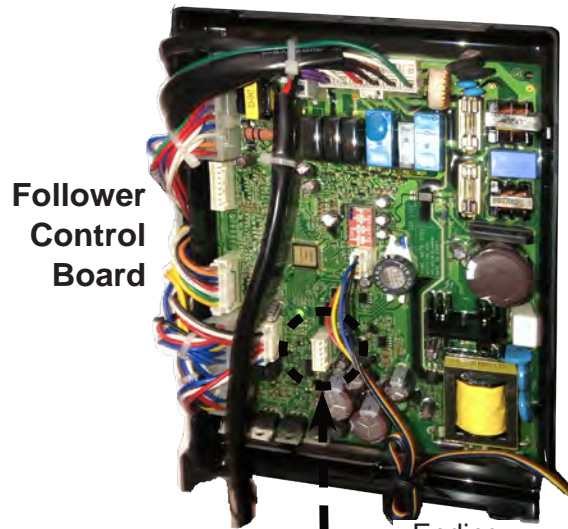

Follower Control Board

Ending Resistor

Last Female Connector.

Plug the included 'Ending Resistor' into it.



Figure 23. Cascade wiring for FT Wall-Mounted models

3.C Wiring Connections for Cascade (continued)

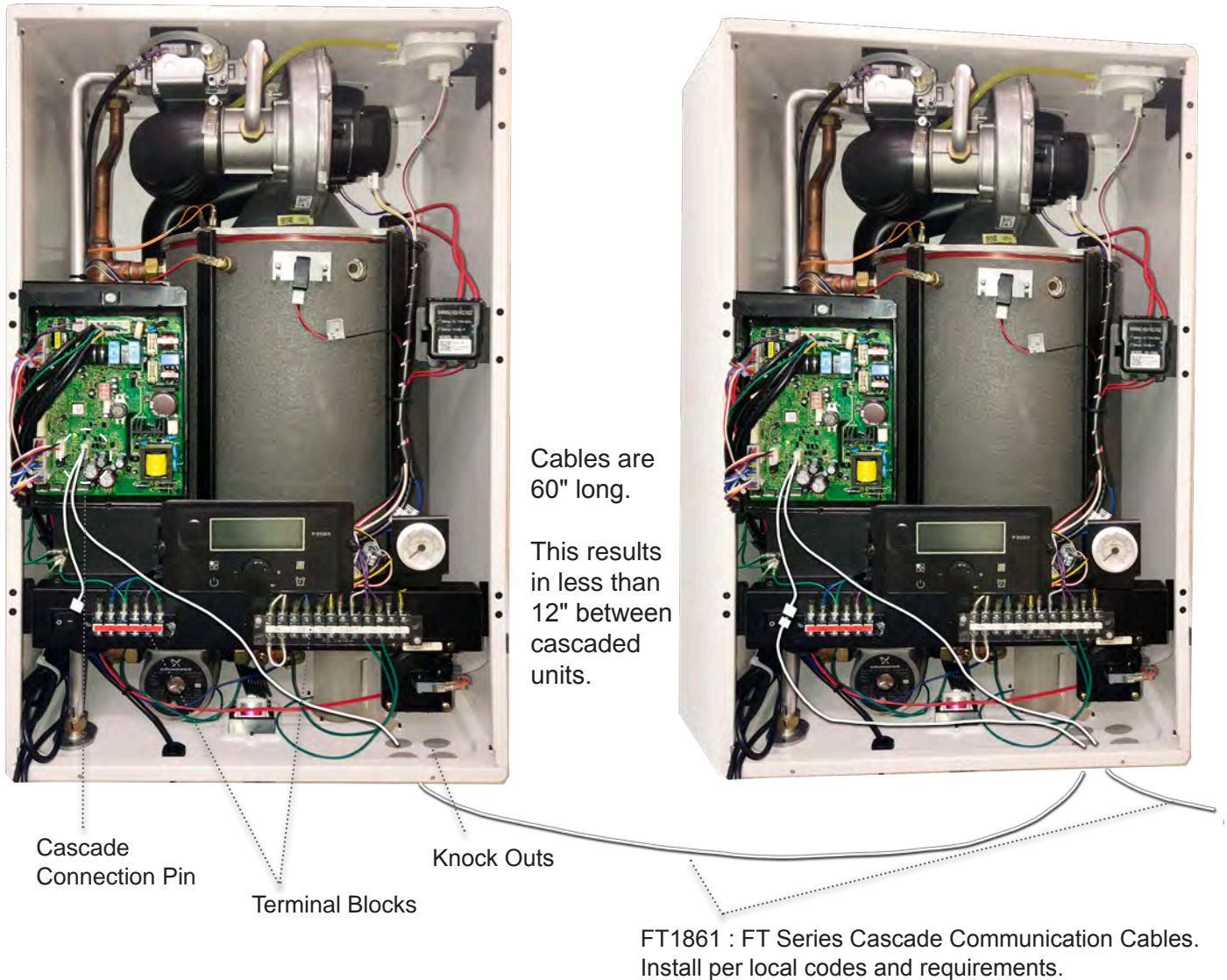

Figure 24. Using the available 'Knock Outs'.

NOTES: The cascading communications cable is 60" long. Routing for the FT Floor models can be via the side floor plastic knock-outs provided. Place boilers within 16" from each other.

Routing for the wall-mounted units can be via the bottom or back side knock-outs. Place unit within 12" from each other. Follow local codes for both systems.

Multiple Cascade Communication cables can be connected for longer distances between boilers. But, each additional Cascade Cable reduces the maximum number of boilers that can be cascaded by one unit.

The cascade system can be activated by a dry contact thermostat (T/T connections on Leader boiler) or by an external 0-10V signal (on the Leader boiler).

In order for the space heating portion of the system to operate properly, the thermostat, 0-10V signal, and/or outdoor sensor **MUST** be connected to the Leader boiler only. The follower boilers will run based on Leader boiler's controls.

Note: The temperature sensor for the indirect water heater must be wired directly to the boiler that is piped to the indirect water heater. If multiple boilers are needed use an aquastat and wire it in parallel with "DHW Temp Sensor" contacts on the boilers to be used for DHW. Ensure the DHW circulator is wired to the "DHW Pump" contacts on a boiler that is piped to the indirect water heater. If there is an active call for Heat and a simultaneous call for DHW, the boiler(s) receiving the DHW call will prioritize the DHW call while the remaining boilers in the cascade will continue to attempt to satisfy the call for Heat.

Reference the FT Series Wall-Mounted or Floor Standing Heating Only Installation and Operation Manual (Doc# 1483 or Doc# 1510) to set the Leader's boiler temperature set point based on an outdoor sensor, 0-10 Volt signal or a fixed temperature setpoint.

In case one desires to shut down certain space heating pumps on a call for DHW, the L leg of the CH pump terminals on the Leader boiler can be used to temporarily interrupt a multi-zone relay panel during priority call for DHW. Please consult the relay panel manufacturer for detailed instructions.

SECTION 4 The Control Display

4.A The Control Display

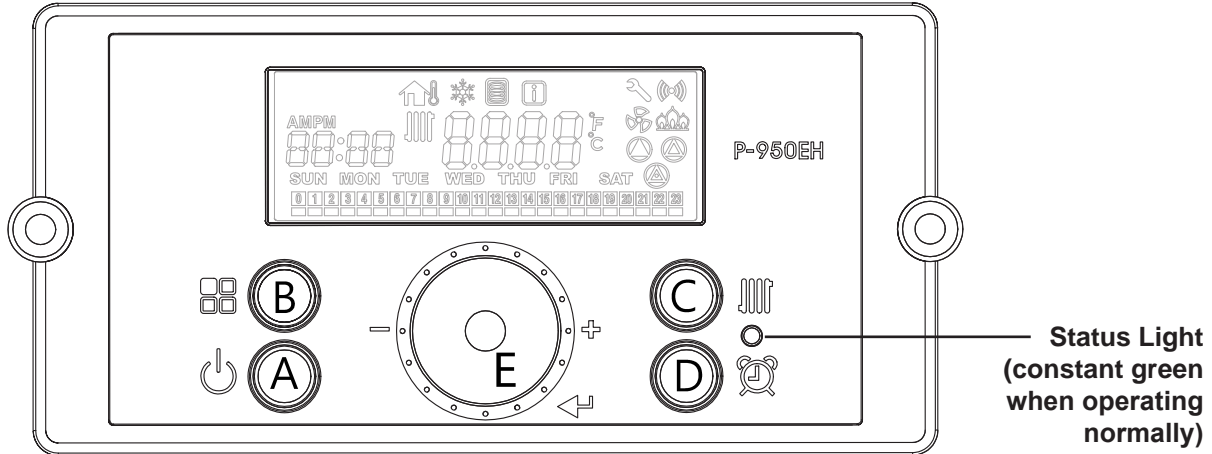

Status Light
(constant green
when operating
normally)

The Control Display has a Control Dial (E), 4 buttons (A, B, C, D), and a Liquid Crystal Display (with 72 back-lit segments). Section 3 will show you only a few of the functions of the FT Series. For all functions, please review the FT Series Install and Instruction Manual. Doc 1342.





Buttons			Functionality	
			PRESS (Tap)	PRESS and HOLD (5 seconds)
A		Display Power	Turns Control Display ON/OFF	
B		Modes	Tap to return to menu	(If Display Power was On) Status Display Mode (If Display Power was Off) Installer Mode
C		Heating Water	CH set-point change mode (Maxium 82°C(180°F))	
D		Time / Date Set	No Change	To SET: Year/Month/Week/Day/Time/Min
E		Scroll / Select	Menu select or value up(+)/down(-) or setting dial.	

Table 1. Controls

- Temperature Specifications
 - Operating ambient Temperature Range : -10 to 60°C.
 - Operating Relative Humidity up to: 90% at 40°C.
 - Shipping & Storage Temperature Range of : -20 to 80°C.

4.B The LCD

The LCD features a backlit lamp that will illuminate when a user presses a button. The display will time out after approximately 2 minutes.

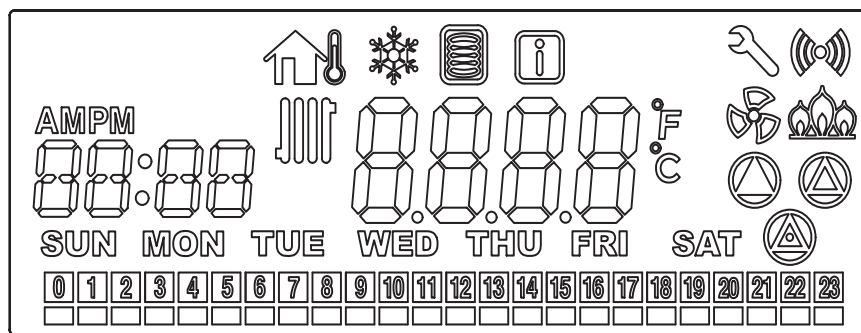

Symbol	Name	Description
	Service Reminder mode	Service Reminder mode indication
	Outside Temperature Mode	Outside Temp setting indication
	Anti-freeze mode	Anti-freeze mode indication
	DHW Demand	Demand Call indication
	Info / Installer mode	Information / Installer mode indication
	Communication state	Communication state indication
	Time setting mode	Time / Display / Install mode indication
	Fan operating mode	Fan operating mode indication
	Flame signal	Flame Signal indication
	Space Heating Pump mode	Space Heating Pump indication
	DHW Pump mode	DHW Pump indication
	Boiler Pump mode	Boiler Pump mode indication
	Celsius mode	Indicated as Celsius temperature
	Fahrenheit mode	Indicated as Fahrenheit temperature
	Heat demand mode	Heat demand mode indication
	DAY mode	Current day mode indication
	Cascade System connecting mode	Cascade System connecting mode indication
	Cascade System operating mode	Cascade System operating mode indication

Table 2. Start-Up Sequence

After the appliance is powered ON, the display shows a sequence of information. The icons will flash, followed by various indicators that describe the appliance controller and software versions. After start-up, the display appears as follows.

The Control Display can operate through user and service modes that have specific LCD outputs and dedicated controls, including:

- Changing the Set-Point Temperature
- Error Mode
- Status Display Mode
- Installer Mode

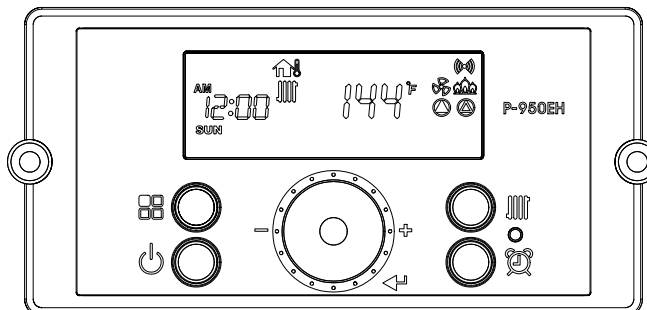



SECTION 5 Cascade Programming

5.A Programming a Cascade System

Before connecting the cascading cables to the boiler, there are 2 items that need to be programmed on all units. Start with the Lead Unit and then Repeat on all Following Units, make sure to power down each unit after completing steps 1 thru 6 below. Once completing steps 1 thru 6 on all boilers, connect the boilers using the cascade cables and power up all boilers.

28: cP – (PARAMETER) The **TOTAL NUMBER** of units cascaded. Range: 01 - 20,

27: cn– (NUMBER) This is each unit's **ASSIGNED NUMBER**. Default 00. Range: 00 - 19 with 00 as the Leader, 01 (follower 1), 02 (follower 2), etc.

- START** by turning OFF the Power  to the Display Control.
- Then, with the power OFF, Press and HOLD (5 seconds) the  button to get into the Installer Mode.

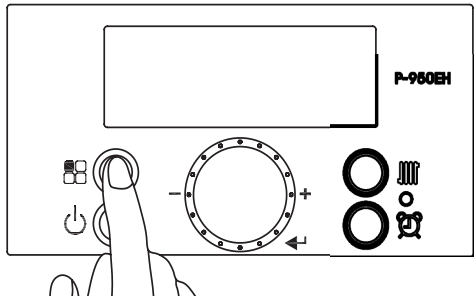

- Rotate the Dial until you get to 28cP. Tap Dial E to enter into that Parameter.

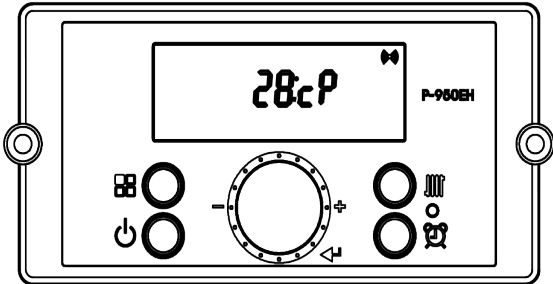

- Adjust to the Total Number of Units in the Cascaded System. Range is Default at 01 and goes up to 20 units. then press (tap) the Dial to save and to Exit.

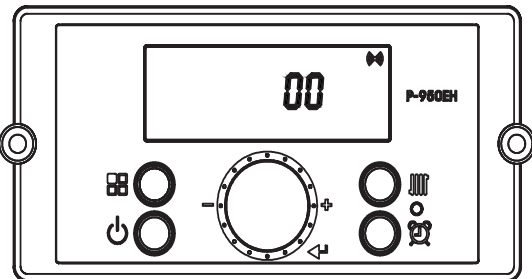

- Then turn the dial to 27:Cn – Set the Number to 00. The Leader unit should always be addressed to 00. The Following units will then start at 01 and go sequentially from there.

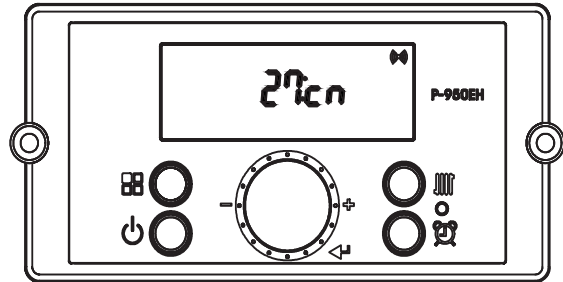

- Finish by pressing the  button.
- REPEAT steps 1 thru 6 with all following units in sequence.

NOTE: Do NOT change 29:Eh (Common Vent). This Installer Parameter must always be set to 'Off'.

- When returning to the home screen, you will see properly addressed cascade units displayed in the bottom left corner. The address of each boiler is displayed in a box and a line underneath it indicates that it is firing. If there is no line under it, then it is not firing.

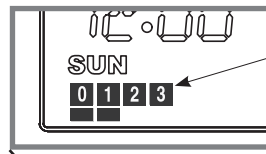

Example showing 4 boilers cascaded with 2 of them currently running.

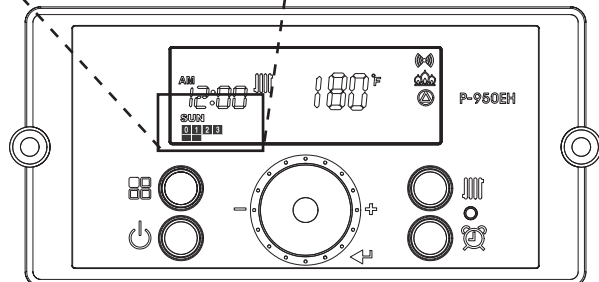

5.B The Cascade CH Function for Set Point Operation



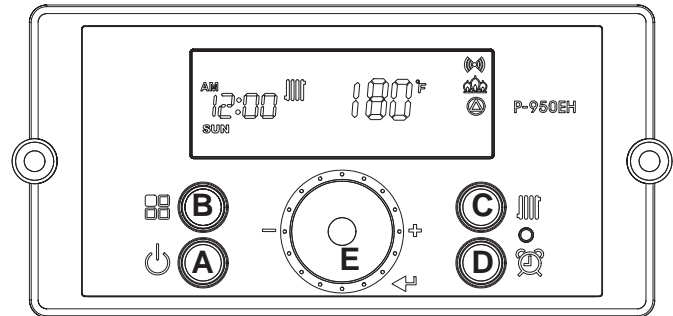

(Applicable when not using an outdoor sensor.)

Changing the CH Set-Point,

press the C  button. The CH Icon and current CH Setpoint will flash. Turn the E dial clockwise to increase, and counterclockwise to decrease CH setpoint, until desired temperature is reached. Press E dial to save changes and to Exit.



NOTE: When you set the temperature set point on the Leader Boiler, it will automatically be applied to the followers.

Indicate	Indicator
Current CH Temperature Set-Point	
Celsius or Fahrenheit	°C or °F
If Communication state is activated	
If flame is detected	
Date and Time indicator	AM PM 88:88
If CH pump is operating	
If there currently a Demand for Central Heat (CH)	

Default CH set-point is 180°F (82°C)

CH set-point range is 86°F -180°F (30.0°C - 82.0°C)

1. During a CH (heating) demand, the Leader boiler controls the firing rate of each boiler in the cascade system. In addition, the Leader controls the quantity of cascade boilers firing in response to a demand, and the order in which each boiler is fired in response to a demand. (Operating temperature and clock will only be controlled on Leader unit, but displayed on Follower unit)
2. When Parameter 30 (Cr) is set to "Auto" - Auto Rotation, the Leader automatically rotates the order of boilers responding to a demand to equalize the run time of all the boilers in the cascade system.
3. When Parameter 30 (Cr) is set to "Ct" Cascade Rotation Time, the installer can manually select the number of hours each boiler is fired first in response to a demand before the Leader rotates the order.
4. Cascade mode operates via system sensor. Units shut off when system sensor reaches system target temperature.
5. Each boiler's built-in circulator operates anytime the boiler fires.
6. If a system pump is used it should be controlled by the "CH Pump" contacts on the Leader. The system pump will operate anytime any of the cascade units fire.

Index Numbers		Parameter	Description
17: bo		Set differential temperature to turn burner "ON"	When set, the appliance will operate to heat CH water when water temperature falls below a differential setting. Example: If set point is 180°F and differential is 27°F, the appliance will turn on when CH water temperature falls below 153°F. Range: 5°F - 30°F, Default 30°F
30:Cr	Cr:at	Automatic rotation (default)	The first unit to operate when there is a T/T call is the unit that ran the least amount of time during the prior heat calls (burner ON time). Default auto
	Cr:Ct	Cascade Rotation time	Cascade Rotation time, Range: 0-240 Hours, Default 48Hours
31: Ct		Cascade System temperature	Cascade System temperature: Range: 95°F – 180°F, Default 180°F
32: Cd		Cascade System Temperature Differential (burner ON)	Cascade System Temperature Differential (burner ON) Range: 5-30 °F, Default 10 °F

5.C Outdoor Reset Operation:

It is required to connect the cascade sensor for cascade operation, and outdoor sensor for outdoor reset operation. Once connected, the Lead boiler will communicate the values automatically to the Follower boiler(s). If the outdoor sensor is NOT used, set Parameter 31 to desired cascade temperature. Follow the instructions in the FT Installation and Operation Manual (Section 5.7) to program the Lead boiler to set up the desired heating curve.

5.D Domestic Hot Water 'Storage Mode' for Cascade System.

The boiler cascade system can be set up for Domestic Hot Water by using either a DHW Sensor or DHW Aquastats with a tank. Note that they are setup differently.

The default DHW priority time is 30 minutes and can be adjusted from 0 to 60 minutes using parameter 24: dP, see parameter table below.

Using an Aquastat

When using a DHW aquastat, the aquastat monitors the temperature of the indirect water heater. Connect the DHW aquastat to the "DHW Temp Sensor" terminals of the boiler piped to the indirect water heater. When using a DHW aquastat, Parameter # 39 (39:SA) must be set to "AquA". The boiler setpoint temperature during a DHW demand is determined by Parameter #25 (25:ST). Connect the DHW Pump to the "DHW Pump" terminals of the boiler piped to the indirect water heater. A relay is required if the DHW pump draws more than 2 amps. Confirm the aquastat is fully inserted in the tank well to ensure accurate temperature readings.

If the DHW load exceeds the capacity of one boiler in a multi-boiler cascade system, multiple boilers can be configured to respond to the DHW demand using the following steps:

- Confirm the indirect water heater, DHW pump, and piping between the boilers and the indirect water heater are all properly sized for the combined flow and output of the boilers.
- Wire the aquastat in parallel to the "DHW Sensor" terminals of each of the boilers selected to respond to a DHW demand.
- Wire the DHW pump to the "DHW Pump" terminals of the first among the boilers selected to handle the DHW load. A relay is required if the DHW pump draws more than 2 amps.

The boiler(s) to which the aquastat is connected will switch to DHW production, allow the burner to ramp up in modulation and increase the output temperature in response to a DHW demand. In addition, each of these boilers will switch power to their respective DWH Pump terminals. Boilers that are NOT connected to the aquastat will continue to operate for space heating and try to maintain cascade system temperature.

5.D Domestic Hot Water 'Storage Mode' for Cascade System (continued)Using a DHW Sensor (thermistor type)

When using a DHW sensor, the boiler monitors the temperature of the indirect water heater. Connect the sensor to the "DHW Temp Sensor" terminals of the boiler piped to the indirect water heater. When using a DHW sensor, Parameter # 39 (39:SA) must be set to "SEnS". The temperature of the DHW in the indirect water heater is determined by Parameter #21 (21:dh) in the table below. The sensor differential is determined by parameter #22 (22:dd) in the table below. The boiler setpoint temperature during a DHW demand is determined by Parameter #25 (25:st) in the table below. Connect the DHW Pump to the "DHW Pump" terminals of the boiler piped to the indirect water heater. A relay is required if the DHW pump draws more than 2 amps. Confirm the sensor is fully inserted in the tank well to ensure accurate temperature readings.

Domestic Hot Water Parameters

For a complete list of parameters, reference the FT Series Installation and Operation Manual 1342.

Index Numbers	Parameter	Description
21: dH	Indirect Storage Tank Temperature Set Point	Sets Maximum Indirect storage tank Temperature Range: 95 - 180°F , Default 120 °F
22: dd	Indirect Storage Tank Differential Set Point	DHW Differential Set Point Range: 5°F-30°F, Default 7 °F
23: Pr	DHW Pump Post Run Time	DHW Pump Post Run Time Range: 0-10 Min, Default 1 Min
24: dP	DHW Priority Timer	DHW Priority Timer Range: 0 – 60 Min , Default 30 Min
25: St	Boiler Set-point Temperature for DHW Demand	Boiler Set-point Temperature for DHW Demand, Range: 120 °F– 180 °F , Default 180 °F

Table 3. Index Parameters.

5.E Cascade System Error Codes

For a complete list of error codes, reference the FT Series Installation and Operation Manual 1342.

Er:30	System Sensor Short	<p>NOTE: This error will only appear if the boiler is used in a cascaded system. This Error Code will go away when system sensor is repaired or replaced.</p> <ol style="list-style-type: none"> 1. Check system temperature sensor. Ensure connections are secure. 2. Check system sensor resistance. If resistance is zero, replace the sensor. 3. If the problem persists, replace the main control. <p>NOTE: During the error state the units will continue to operate. Boiler setpoint will be the same as the system sensor setpoint until the issue is remedied. During normal operation boiler setpoint is defaulted to 20°F higher than the system setpoint to a maximum of 180°F setting.</p>
Er:78	Cascade Communication Error	<p>NOTE: This error will only appear in a cascaded system.</p> <ol style="list-style-type: none"> 1. Turn power OFF and ON at the boiler display panel. 2. If error reappears, ensure all cascaded boilers are powered ON. 3. If error reappears, check Installer Mode parameter 28 at the Leader boiler. Ensure the number of cascaded units chosen in this parameter matches the number of cascaded units in the system. 4. If error reappears, check Installer Mode parameter 27 at all cascaded boilers. Ensure the address number matches that of the connected boiler (00 for Leader, 01 for Follower 1, etc.) and that no numbers are skipped or repeated. 5. Ensure every unit in the cascade system is connected properly. Inspect the cascade cables and ensure all are connected without damage or defect. Repair or replace any damaged cables. 6. If the problem persists, contact technical support.

Notes:

H2384200C

